

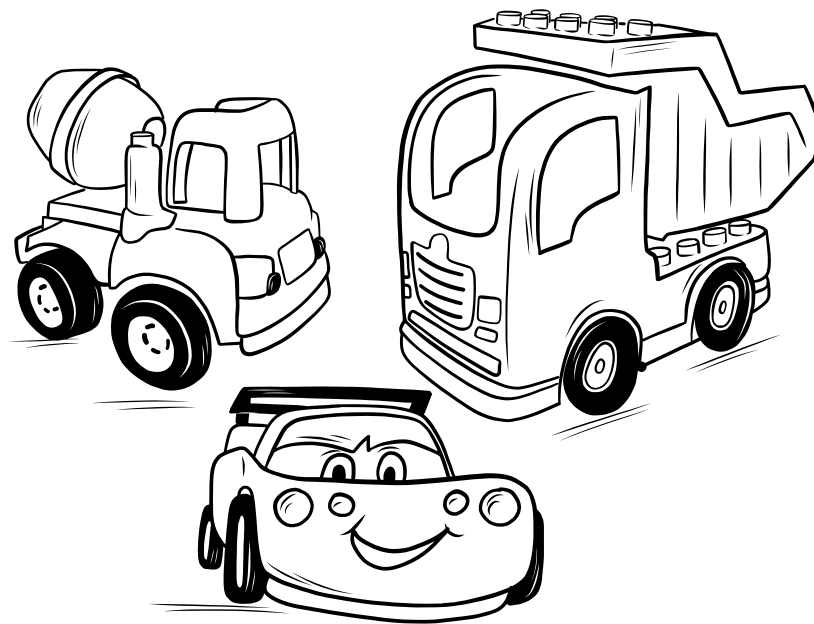

лялька
panenka

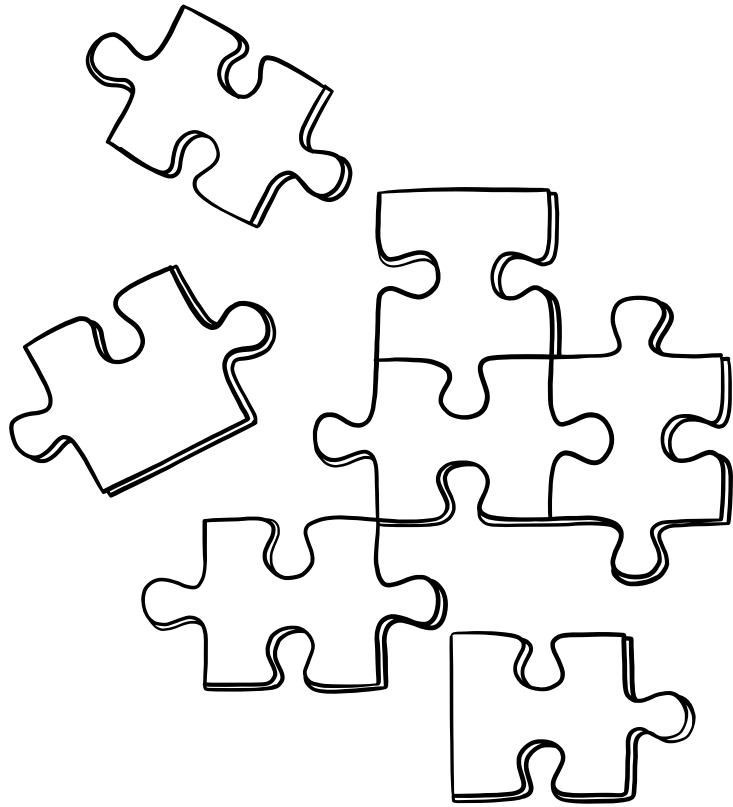

машина
auto



пазл
puzzle

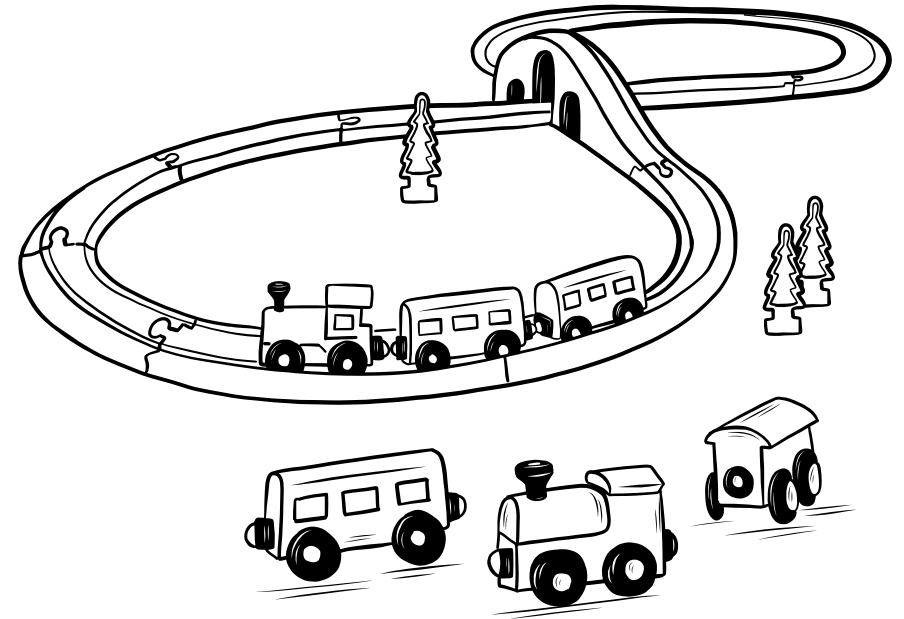

поїзд
vláček

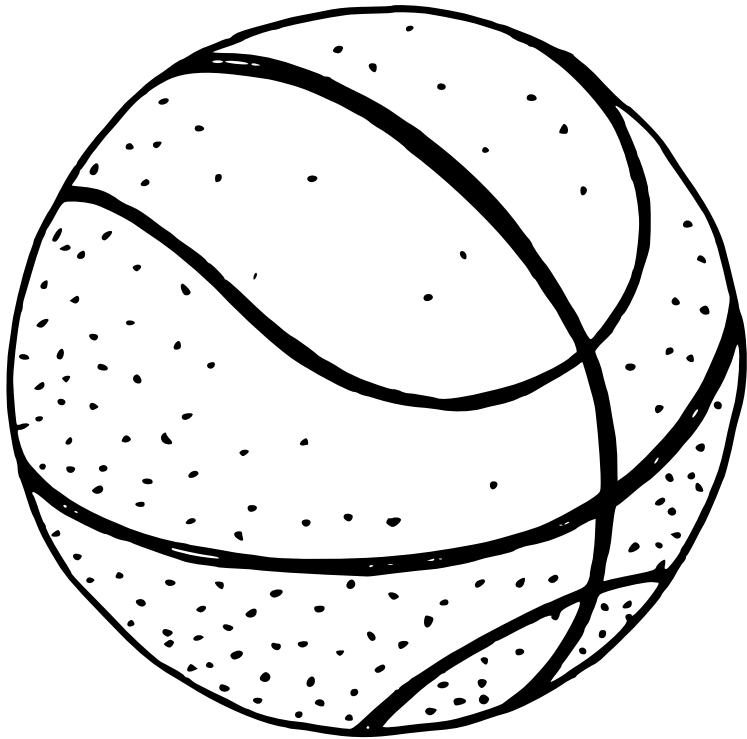

м'яч
tíč



розмальовки
omalovánky



напій
pití



сніданок
snídaně



перекуска
svačina

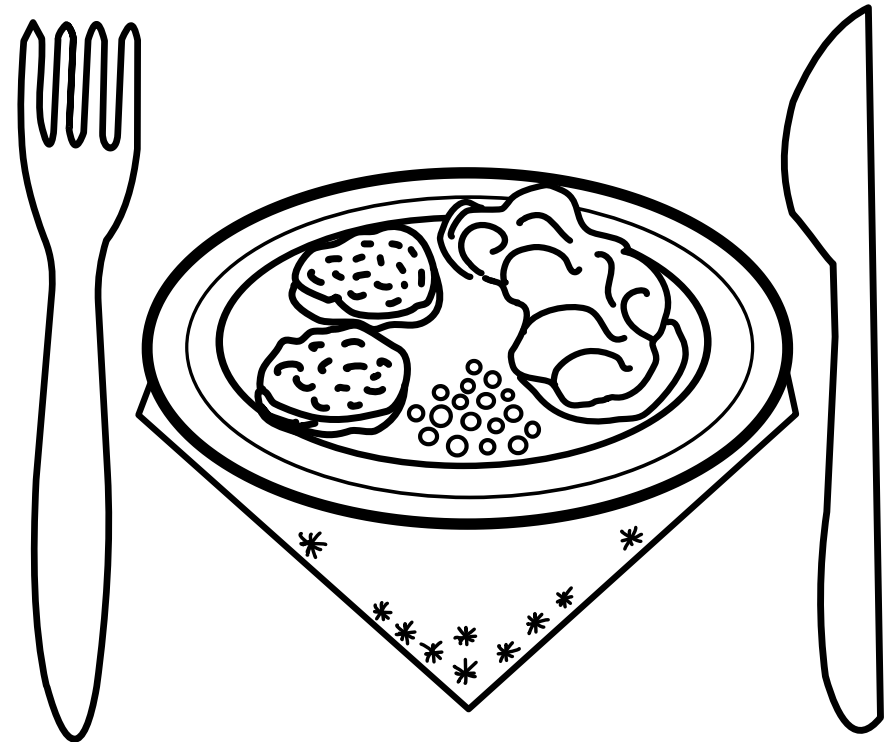

обід
oběd

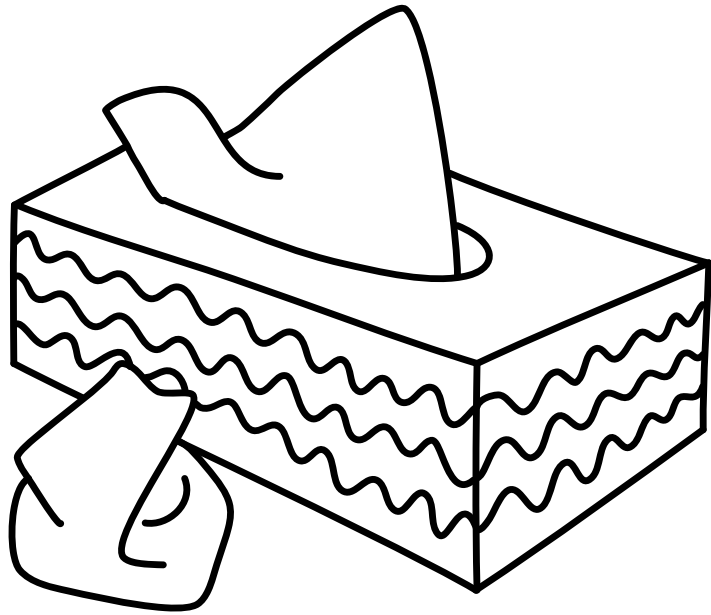

НОСОВА ХУСТИНКА
kapesník



ЛІЖКО
postel



туалет
záchod



подорож
výlet



сад
zahrada

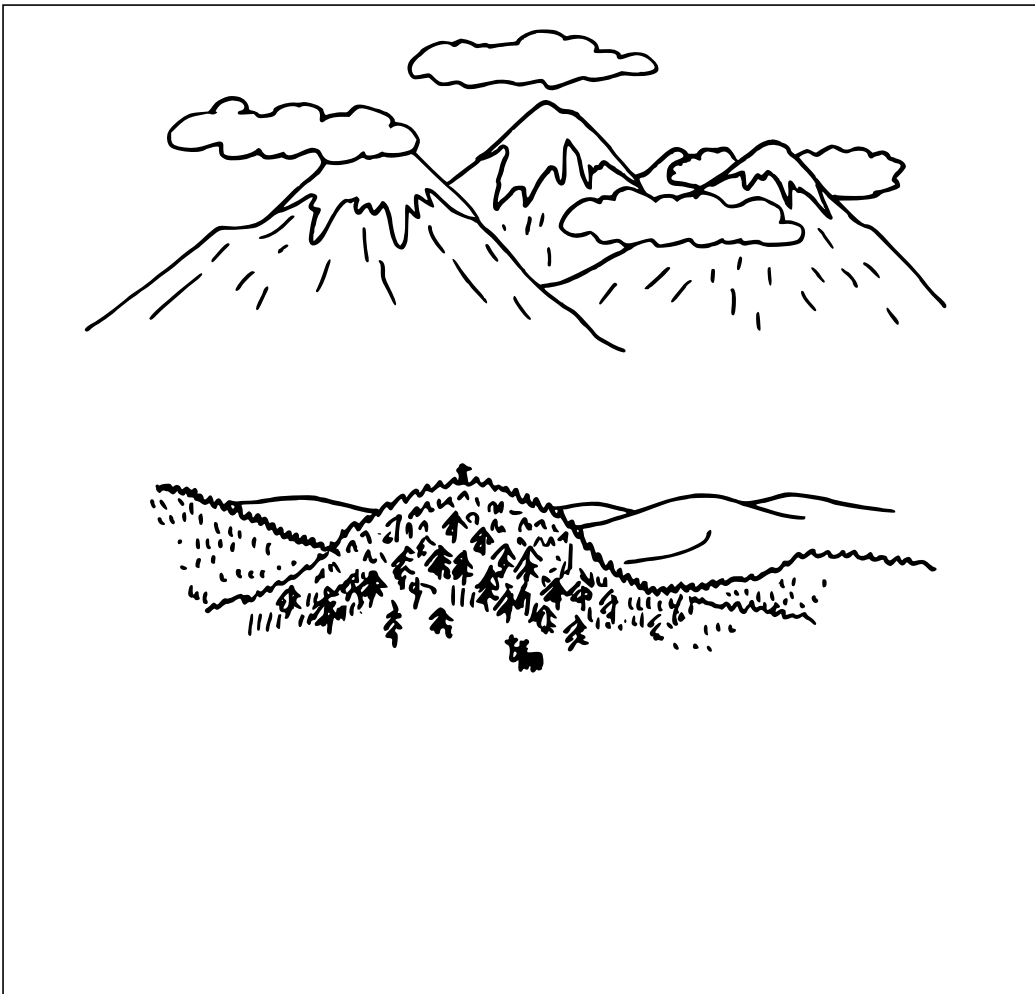

гори
hory



кататися на
ковзанах
bruslit



ЧИСТИТИ зуби
čistit si zuby



робити вправи
світит



У мене болить
живіт.
Bolí mě břicho.



писанка
kraslice



зайчик
zajíček

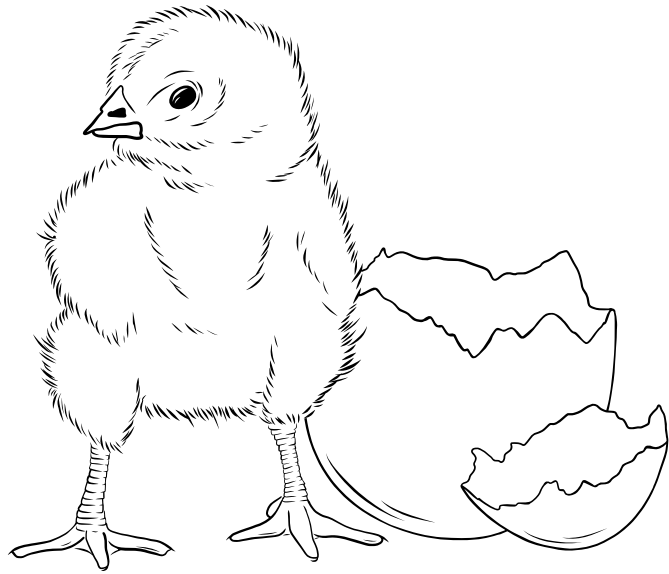

курчатко
kuřátko

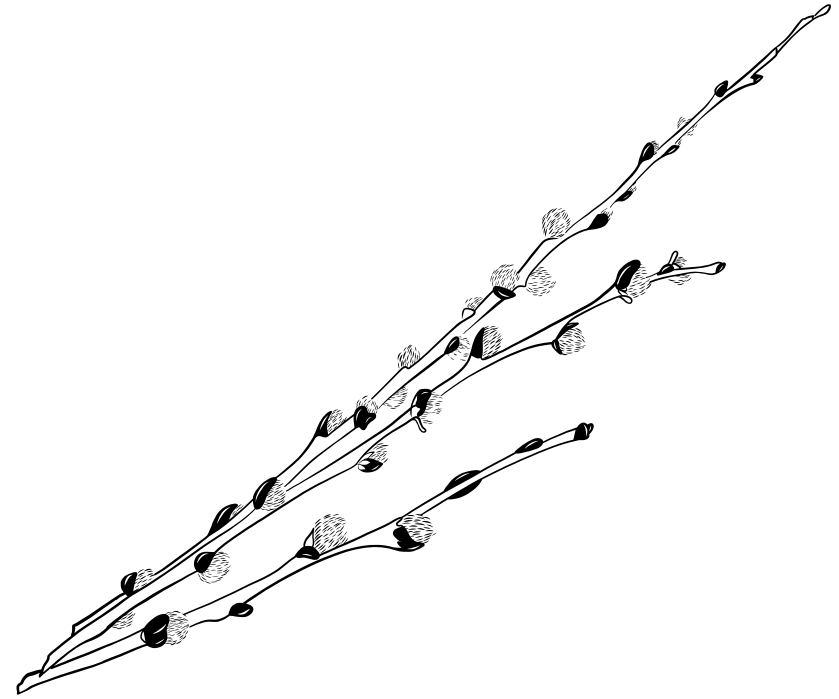

котики (цвіт верби)
kočičky (květy vrby
jívy)



баранець
beránek



примула
petrklič



ТЮЛЬПАНИ
tulipány

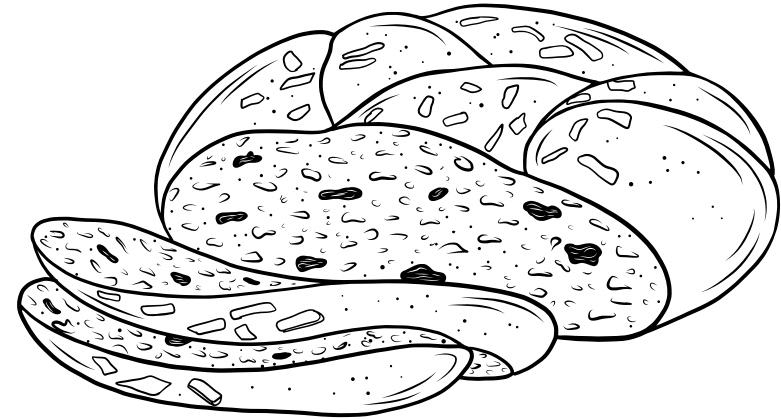

пасочка
mazanec



мак
mák



кульбаба
rampeliška



бузок
šeřík



соняшник
slunečnice

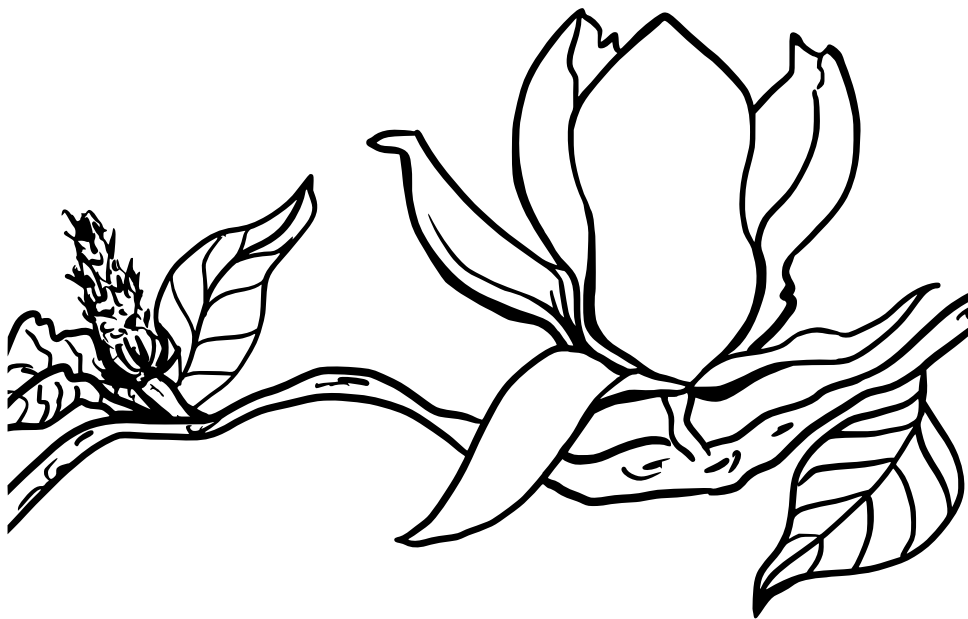

магнолія
magnolie



хоробрий лицар
statečný rytíř



прекрасна
принцеса
krásná princezna



король
král



золотий перстень
zlatý prsten

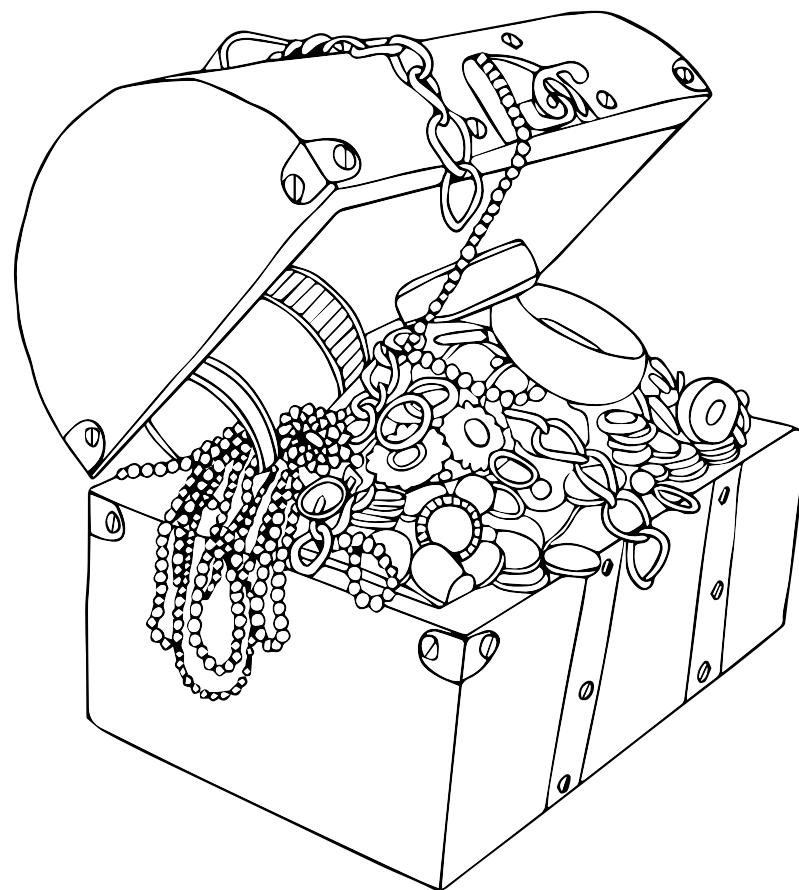

скарб
poklad



триголовий дракон
tříhlavý drak

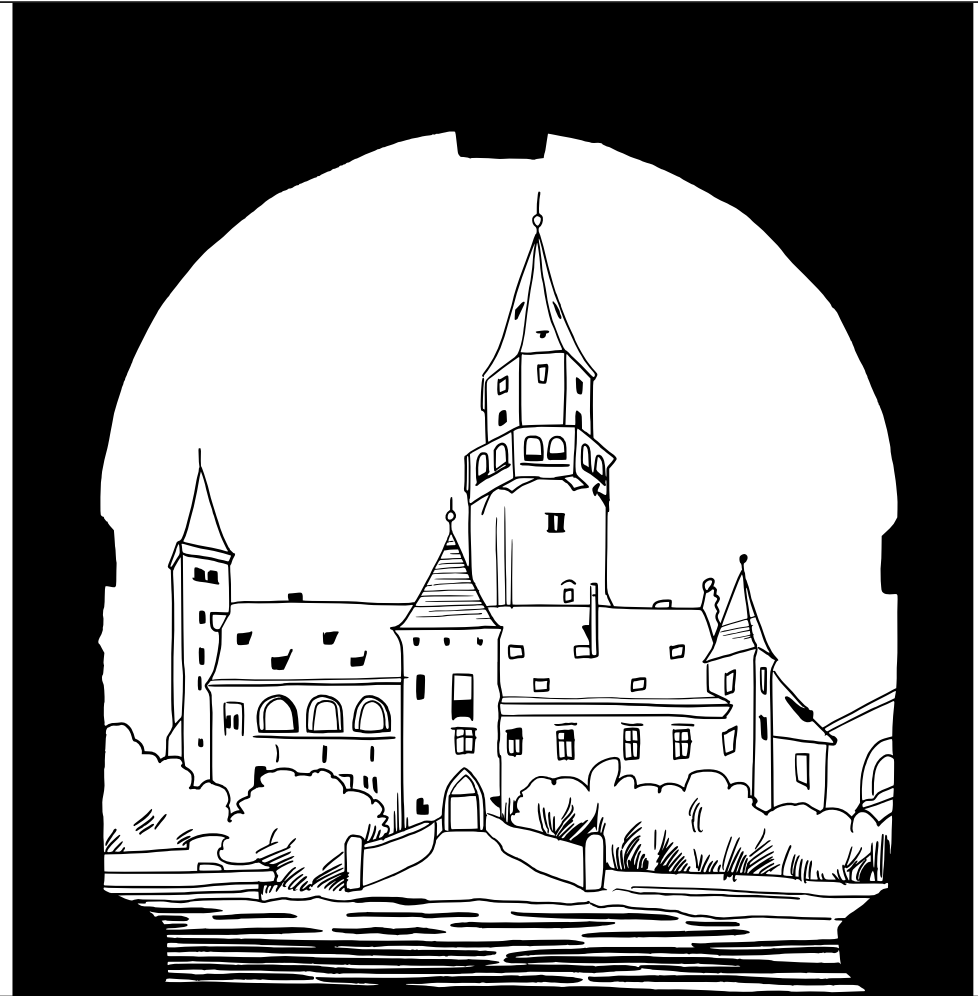

замок
hrad

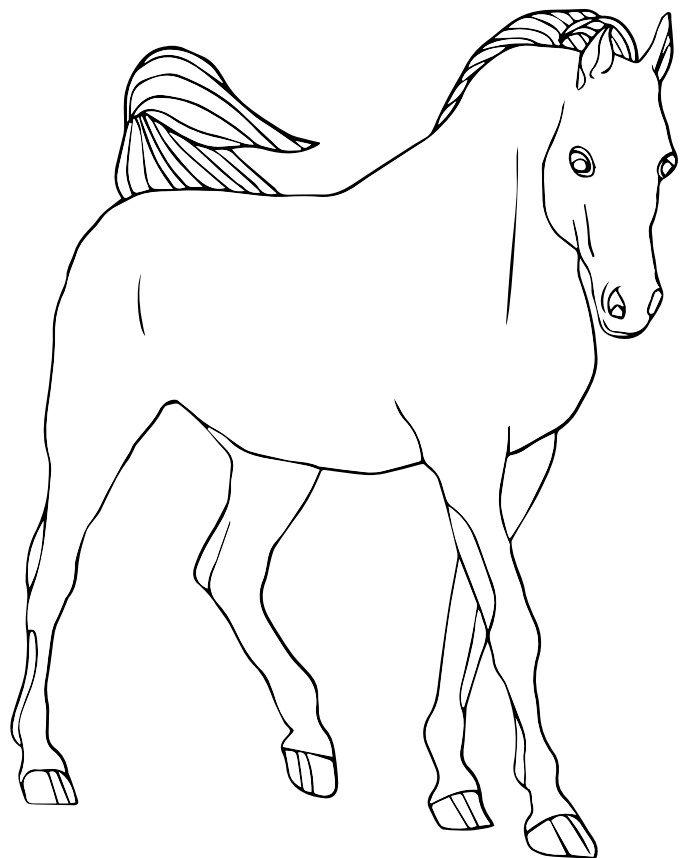

кiнь
kũň



глінтвейн
svařák



короп
kapr

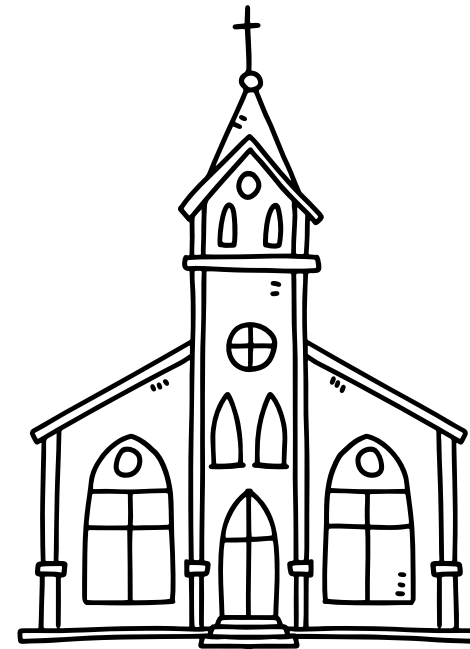

костел
kostel

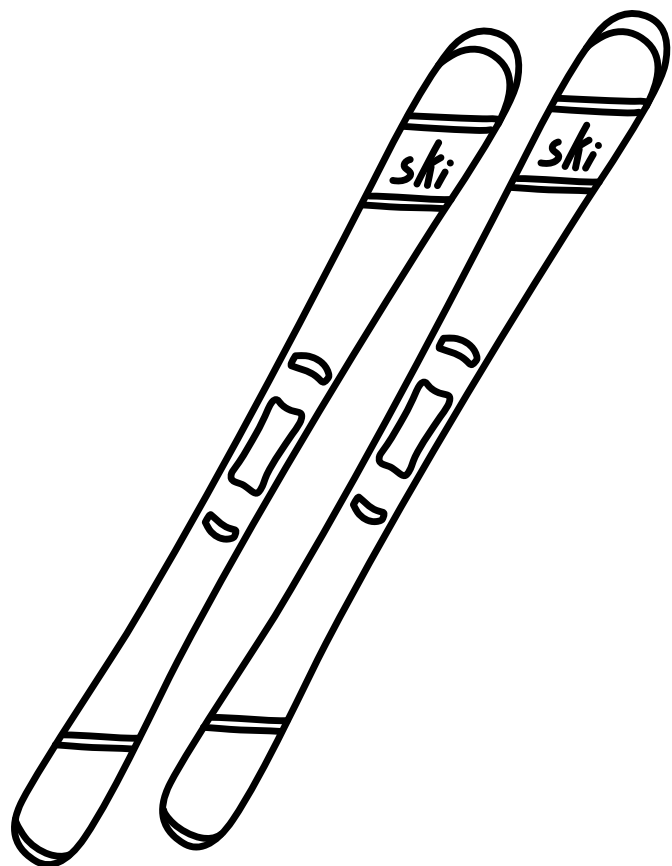

лижі
lyže



лижні штани
oteplováky

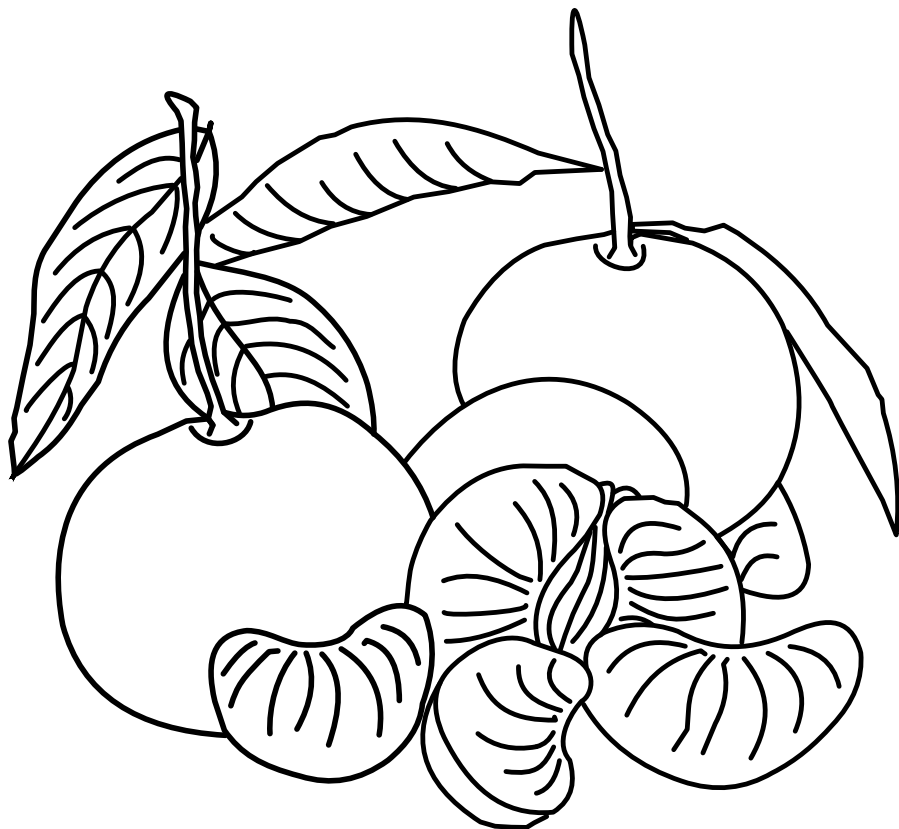

мандаринки
mandarinky

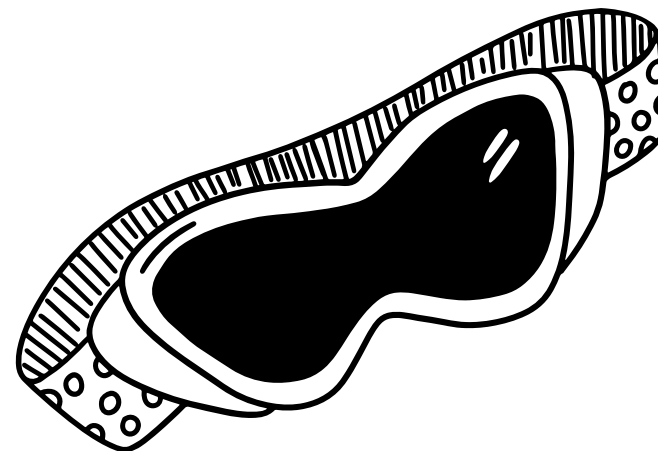

окуляри
brýle



омела
jmelí

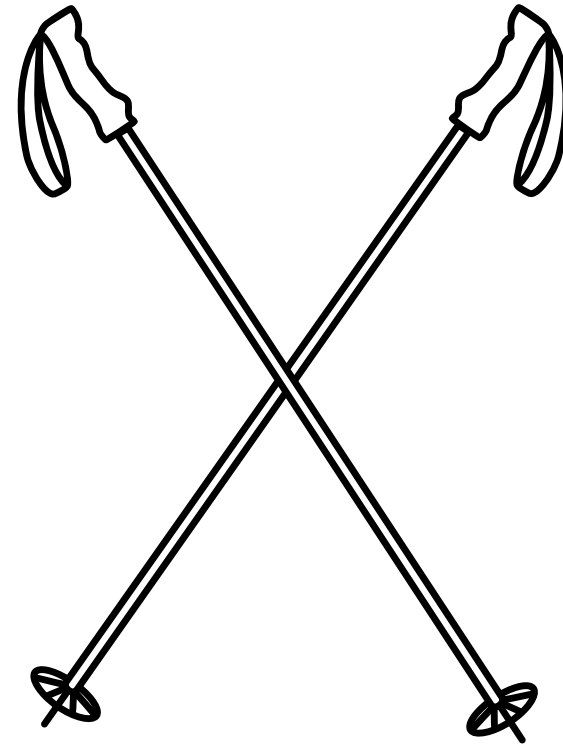

палки
hůlky

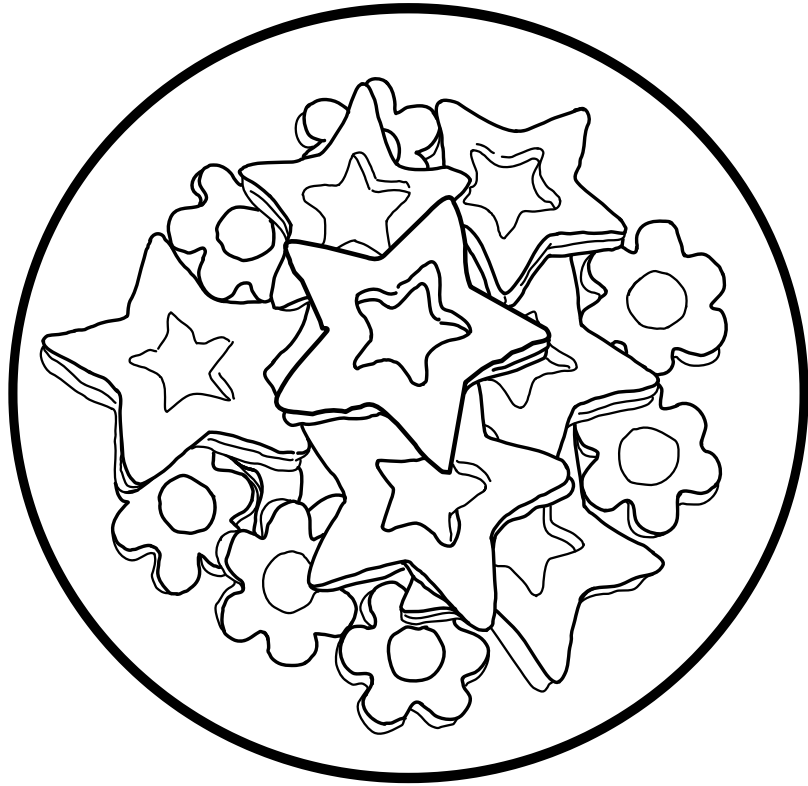

печиво з пісочного
тіста
linecké

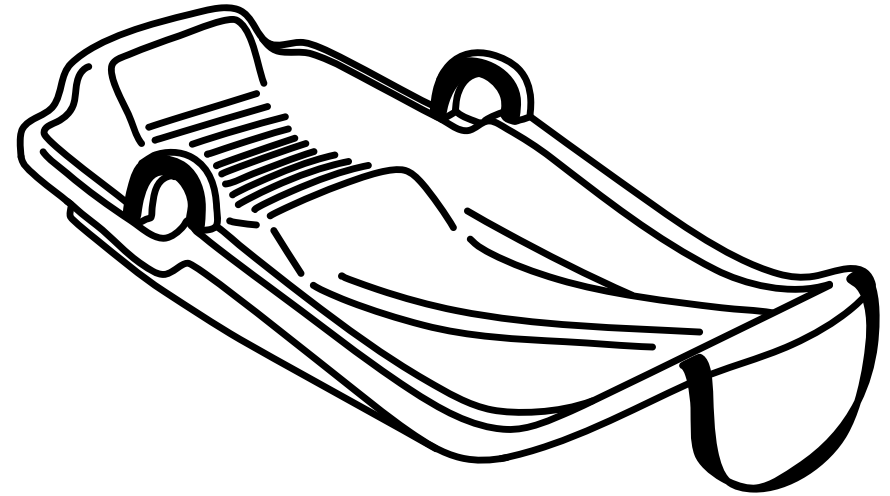

пластикові санчата
boby



подарунок
dárek



прянички
perníčky

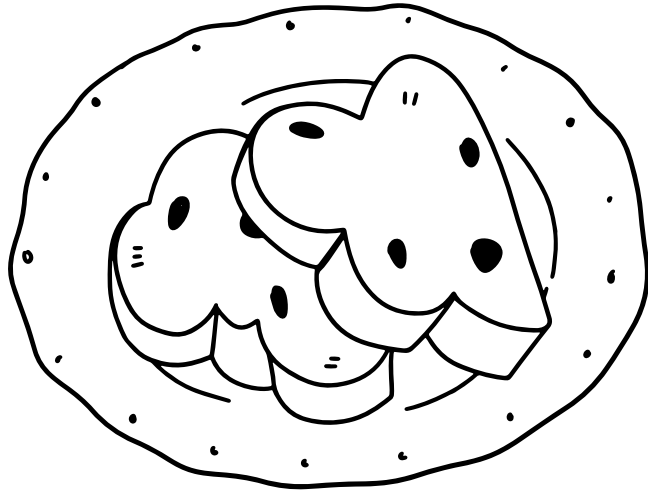

різдвяна булочка-
плетінка
vánočka

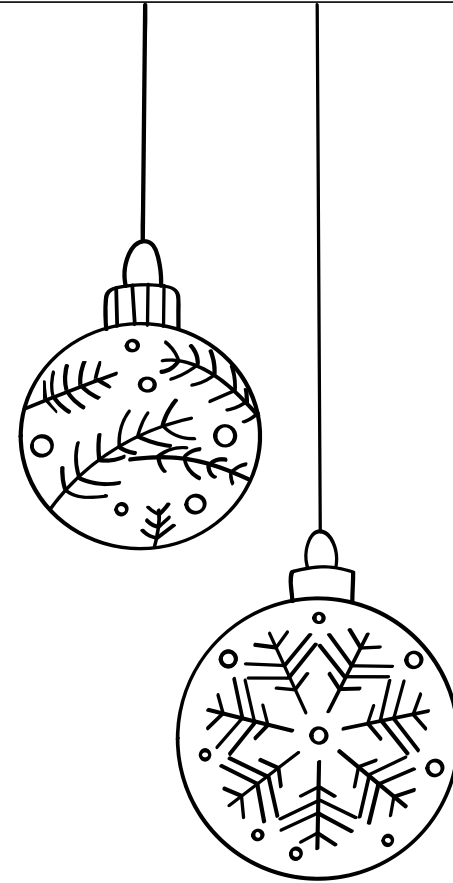

різдвяні прикраси
vánoční ozdoby

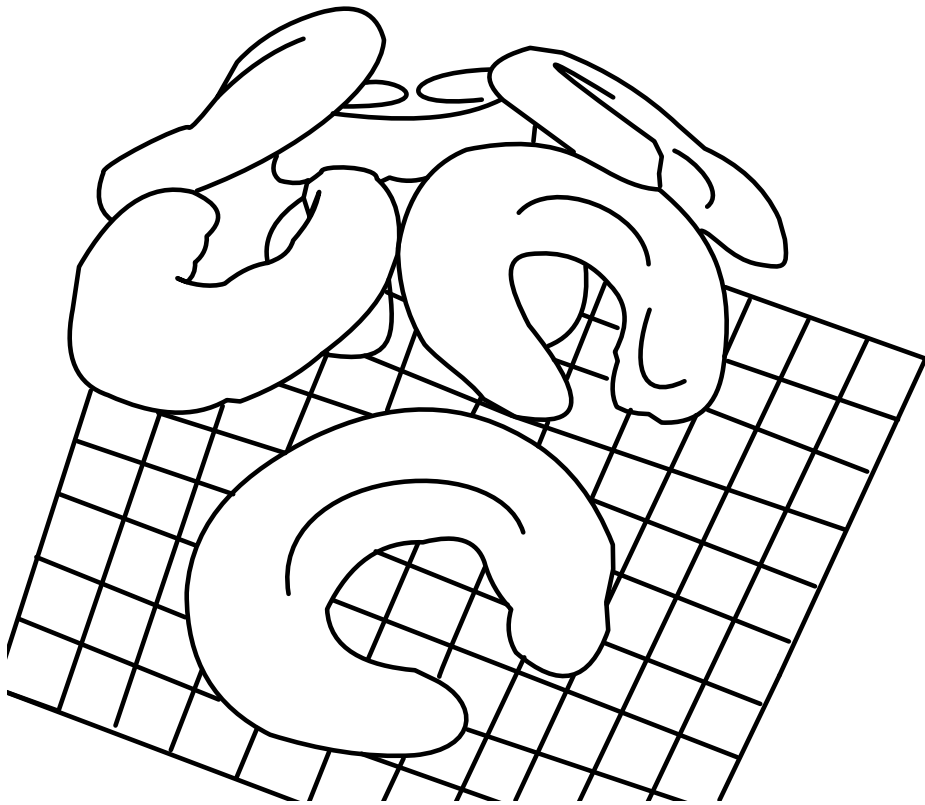

рогалики
rohlíčky

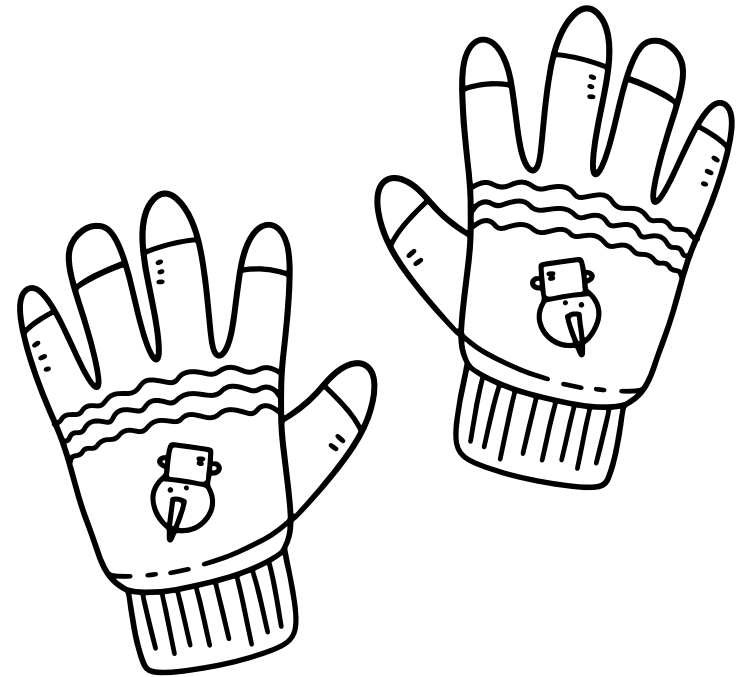

рукавиці
rukavice

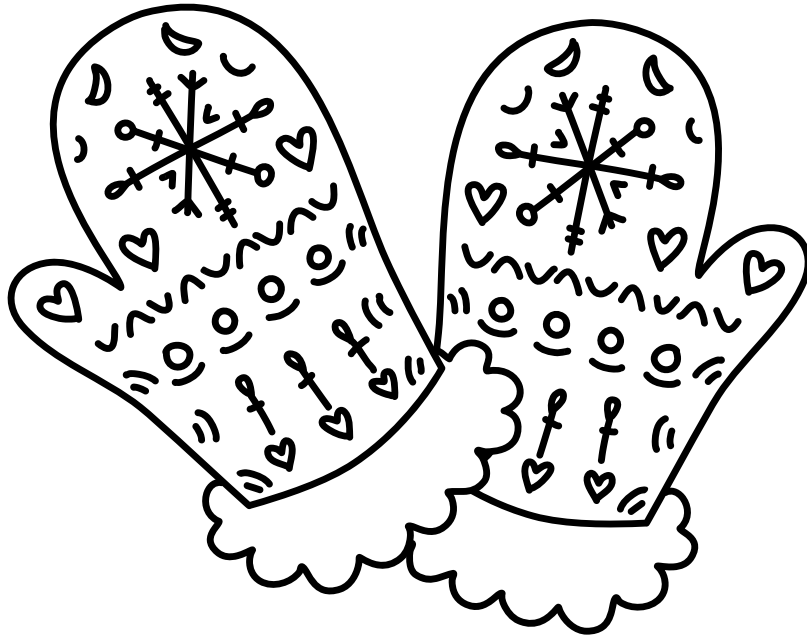

рукавиці (без
пальців)
pačáky



санчата
sáňky

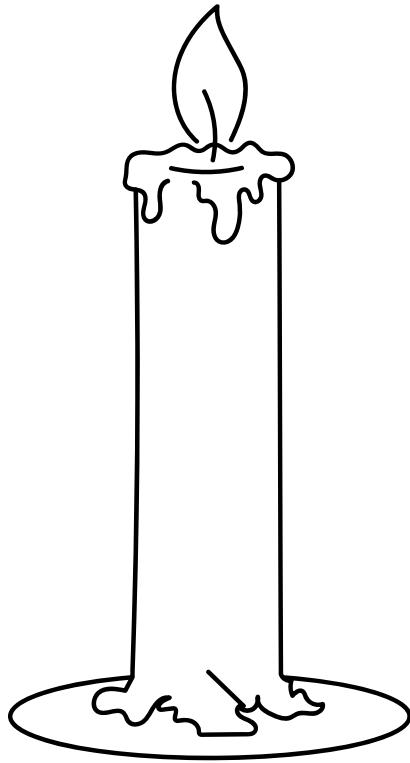

свічка
svíčka

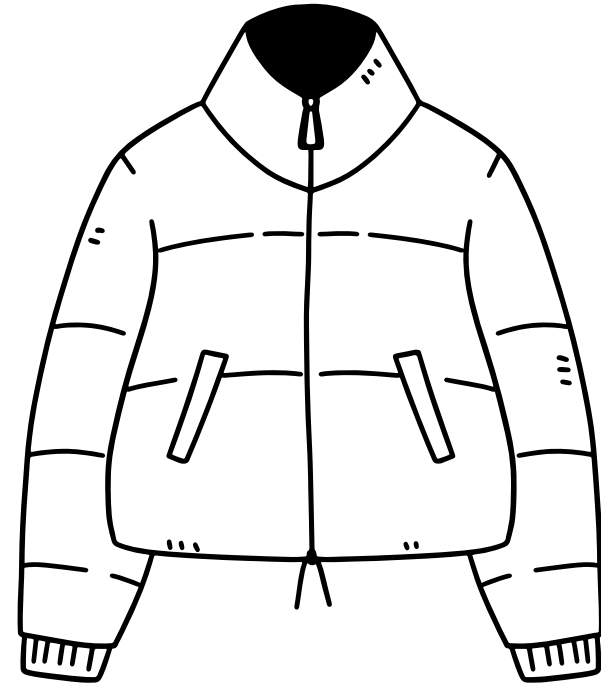

тепла куртка
teplá bunda

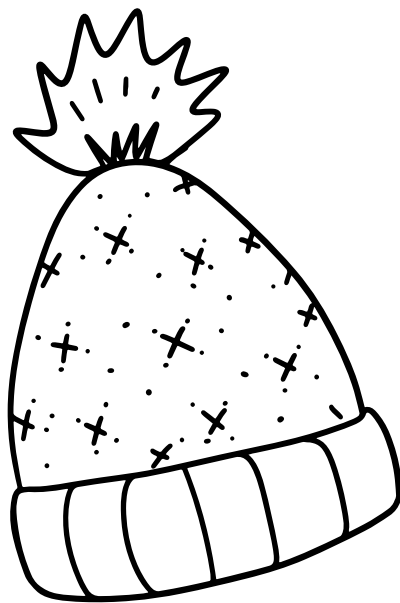

шапка
čerice

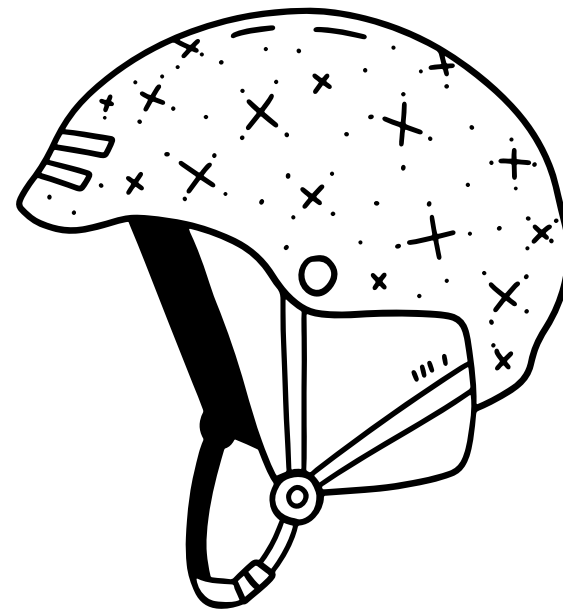

шолом
helma



ялинка
vánoční stromeček



лижні черевики
lyžáky