

panenka  
лялька

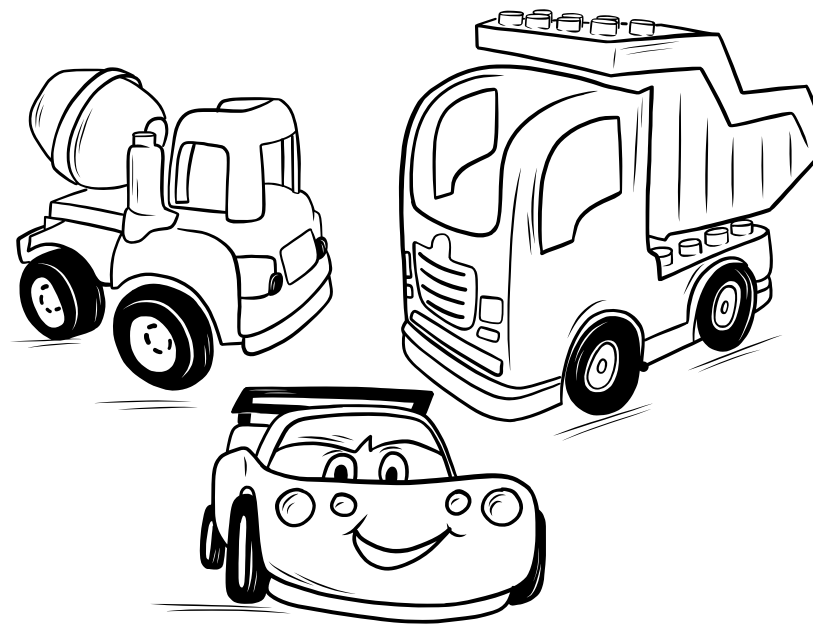

auto  
машина

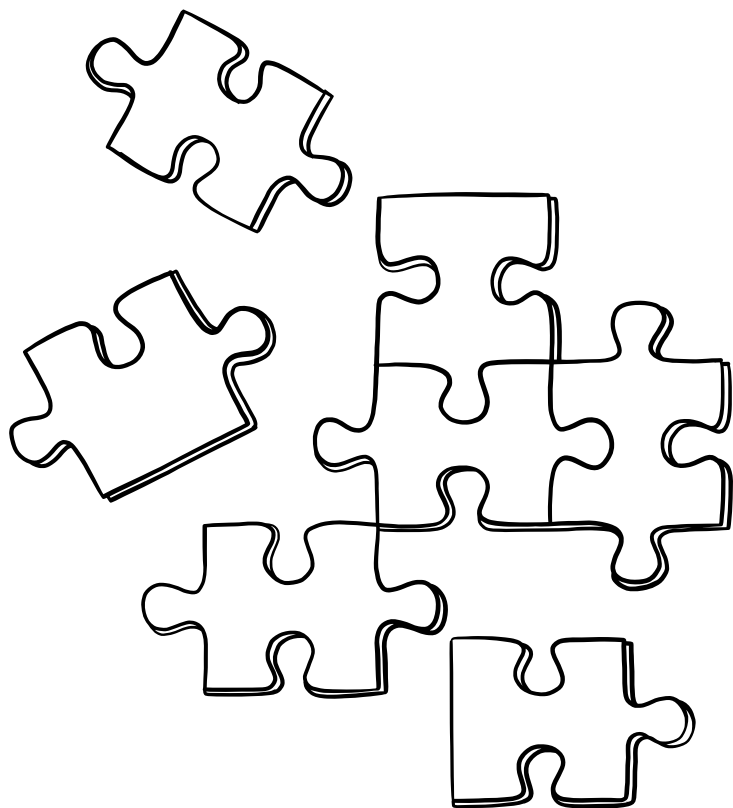

puzzle  
пазл

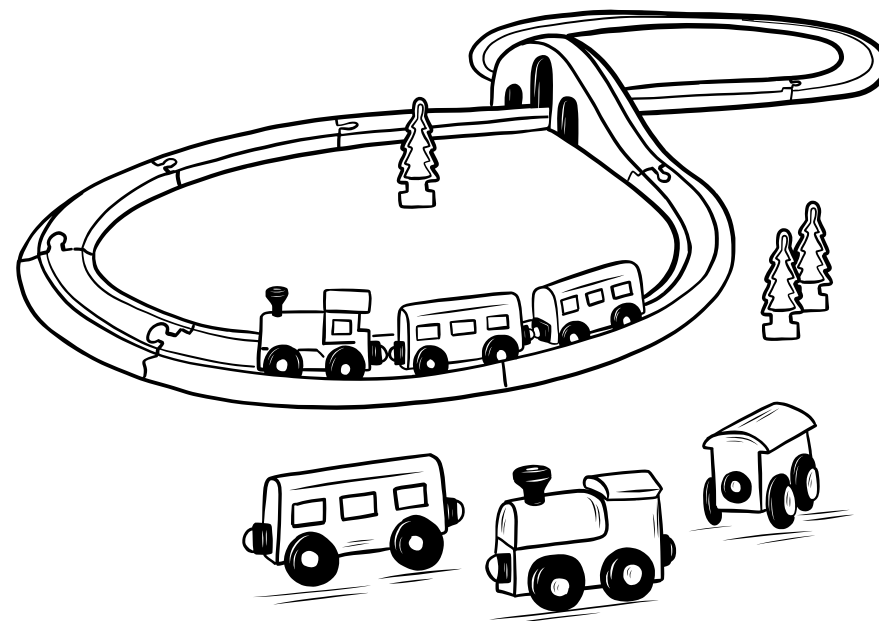

vláček  
поїзд

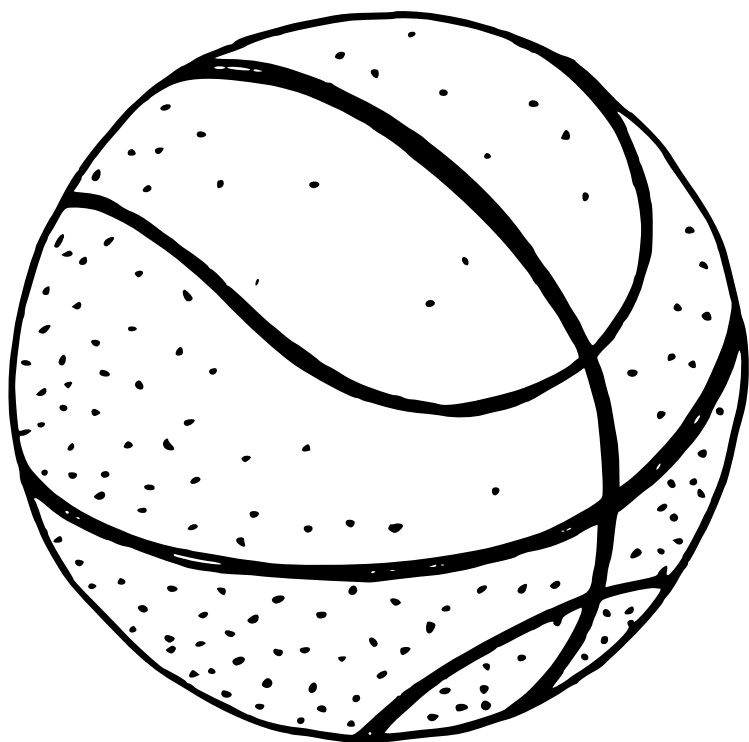

míč  
м'яч



omalovánky  
розмальовки



pití  
напій

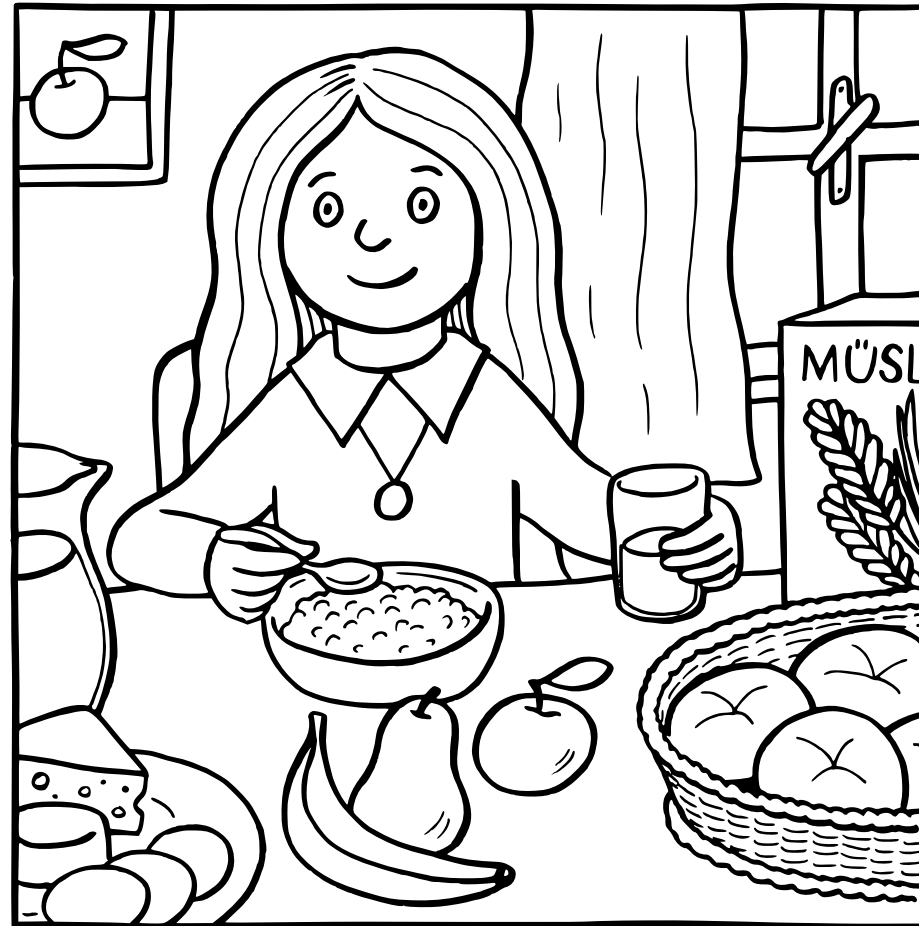

snídaně  
сніданок



svačina  
перекуска

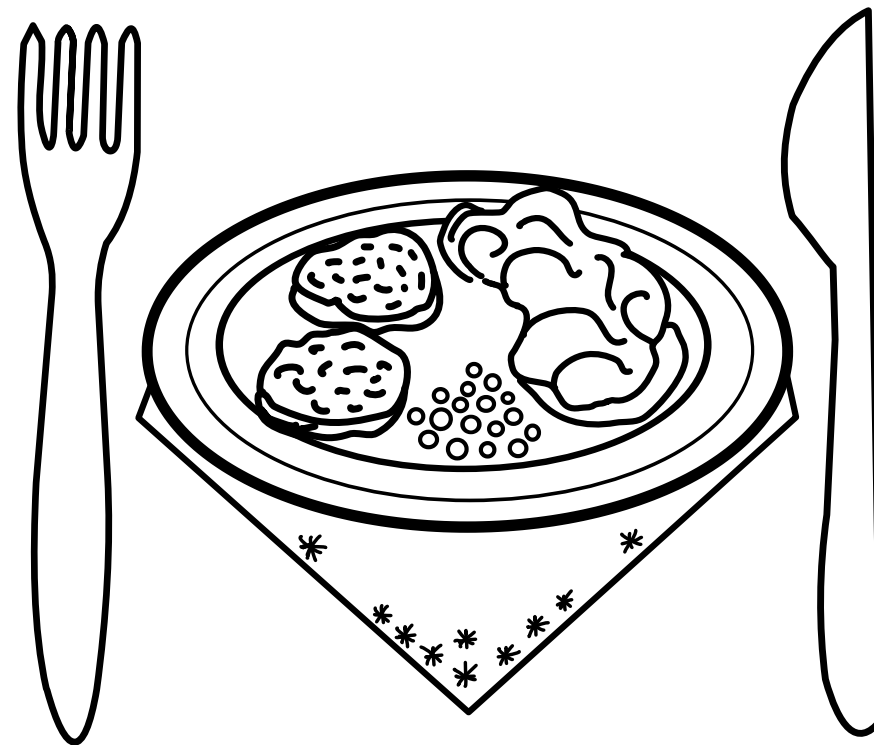

oběd  
обід

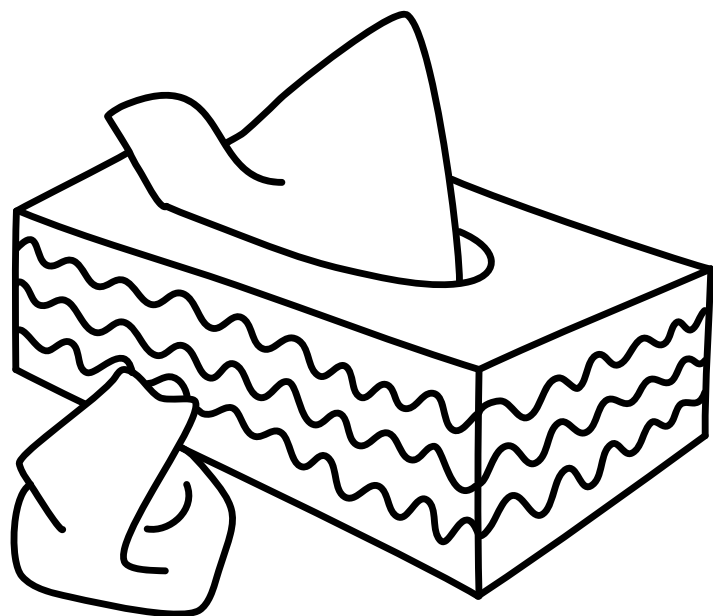

kapresník  
НОСОВА ХУСТИНКА



postel  
ЛІЖКО



záchod  
туалет



výlet  
подорож



zahrada  
сад

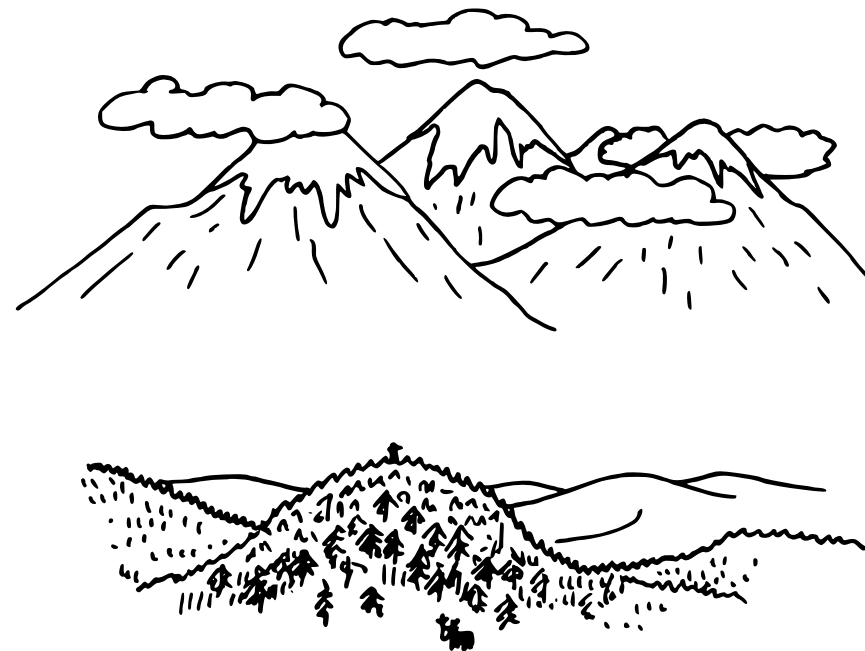

hory  
гори





bruslit  
кататися на  
ковзанах

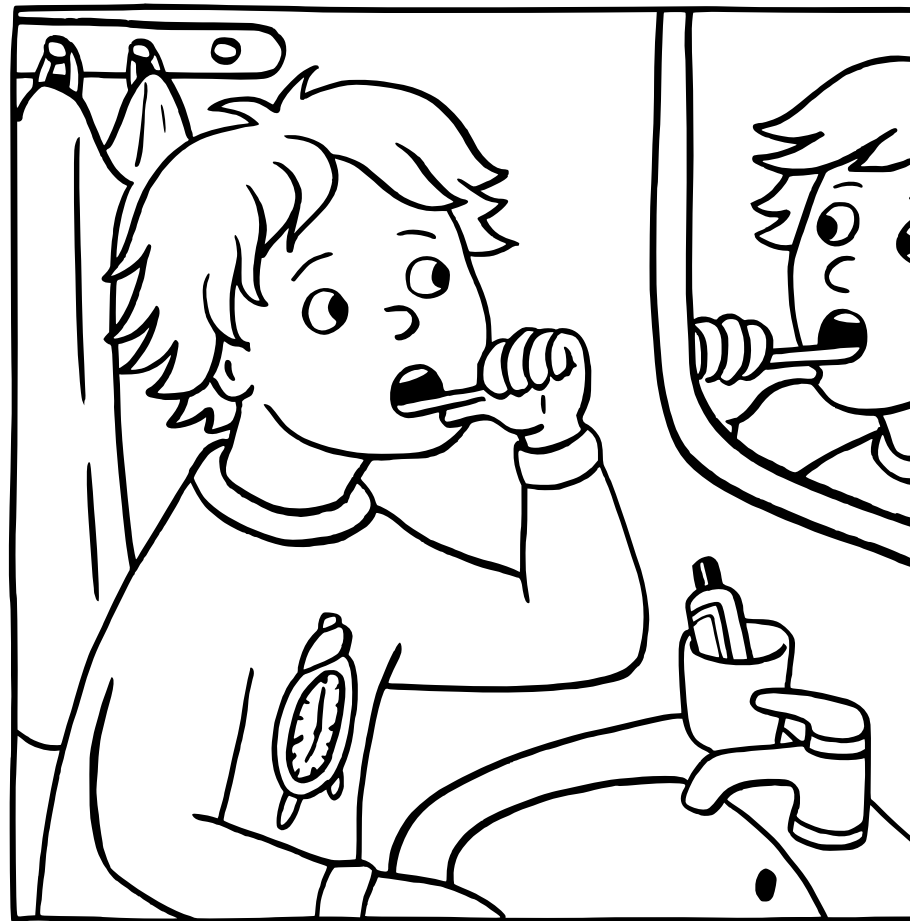

čistit si zuby  
ЧИСТИТИ ЗУБИ



cvičit  
робити вправи



Bolí mě břicho.  
У мене болить  
живіт.

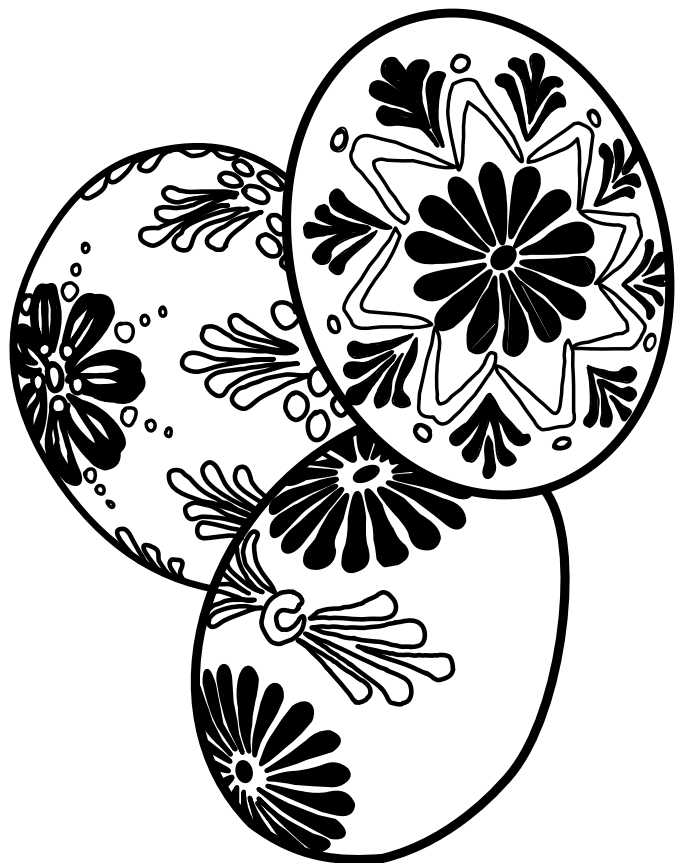

kraslice  
писанка



zajíček  
зайчик

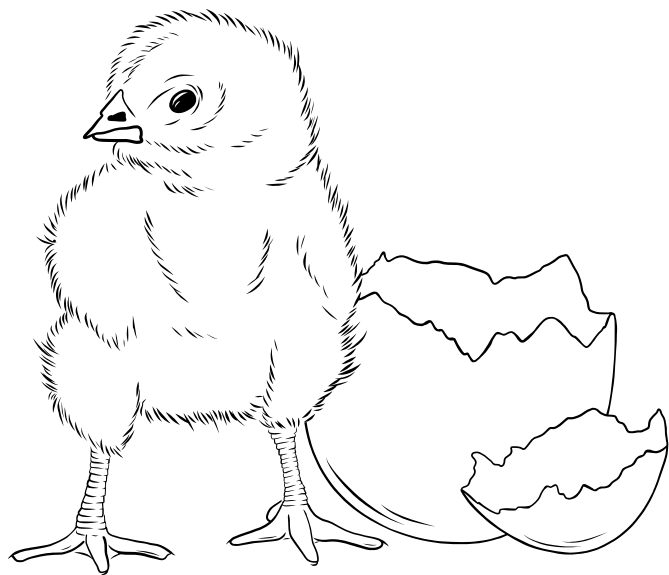

kuřátko  
курчатко

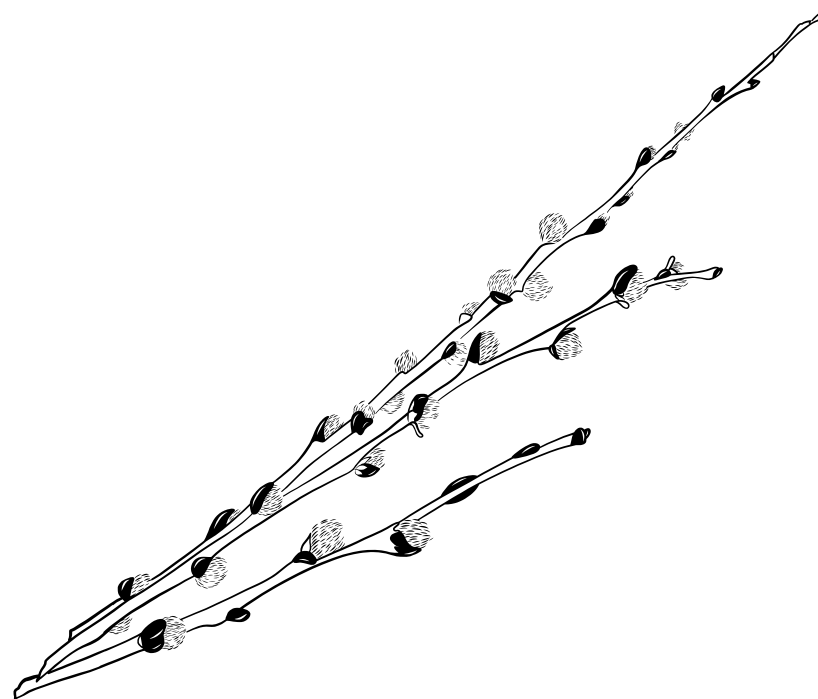

kočičky (květy vrby  
jívy)  
котики (цвіт верби)



beránek  
баранець



petrklíč  
примула



tulipány  
ТЮЛЬПАНИ

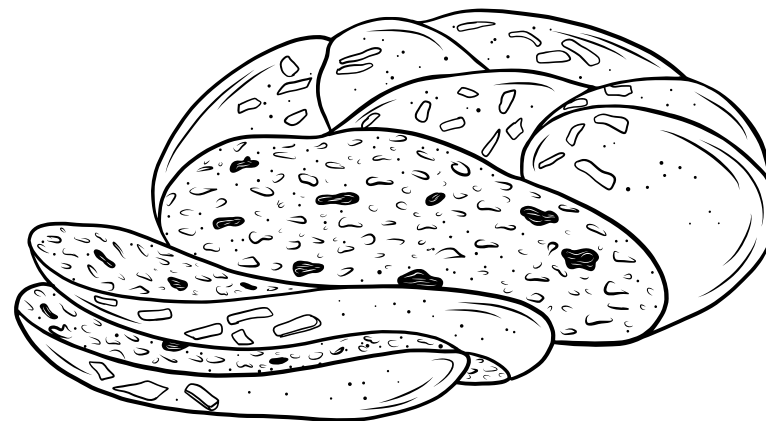

mazanec  
пасочка



mák  
мак



rampeliška  
кульбаба



šeřík  
бузок



slunečnice  
СОНЯШНИК



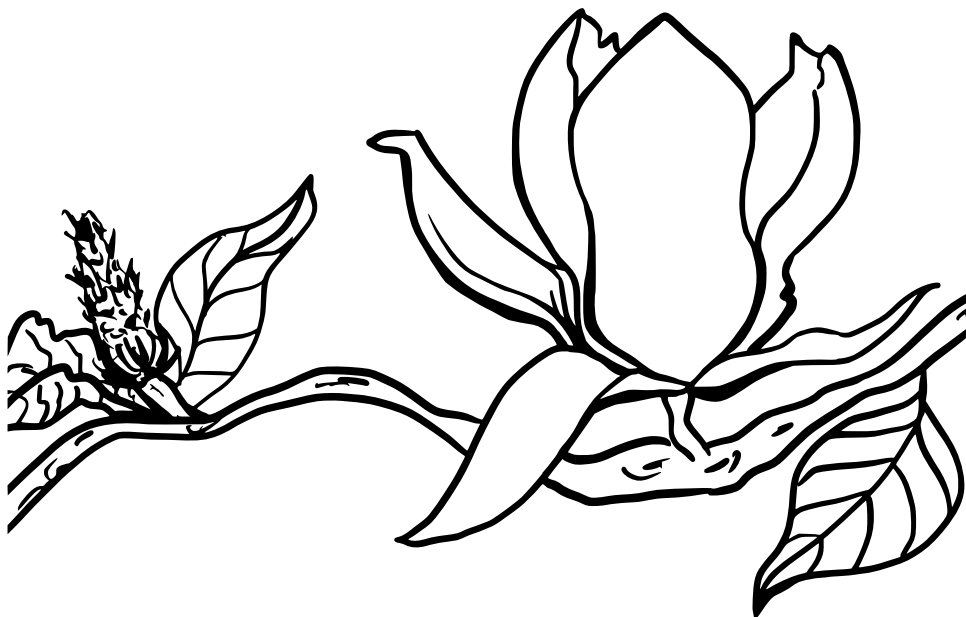

magnolie  
магнолія

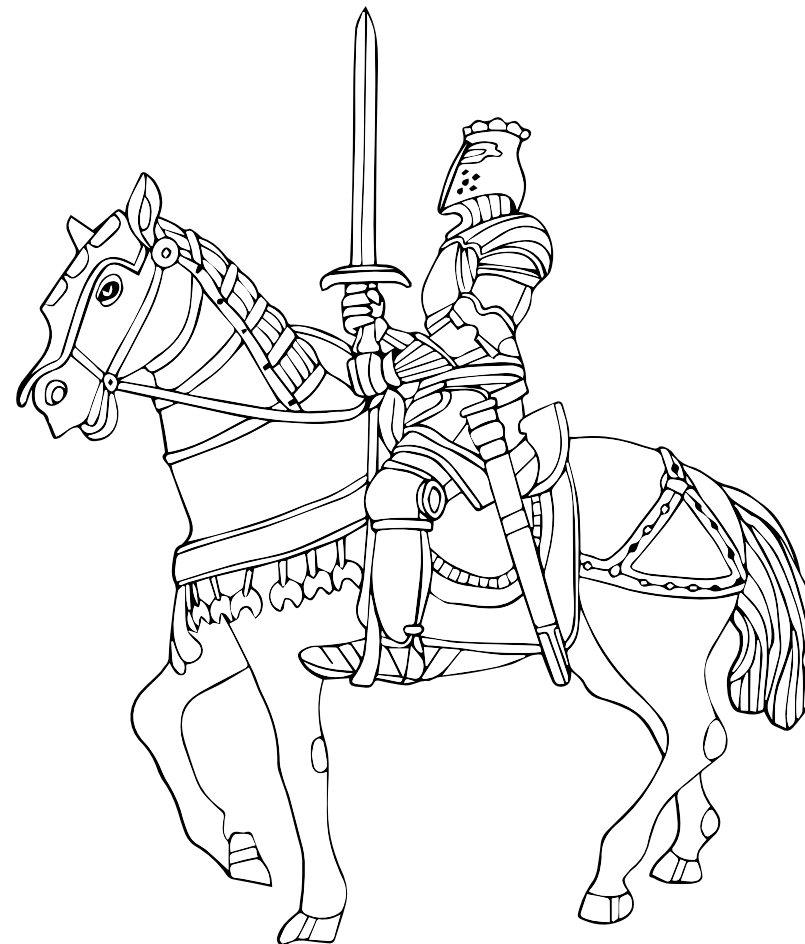

statečný rytíř  
хоробрий лицар



krásná princezna  
прекрасна  
принцеса



král  
король

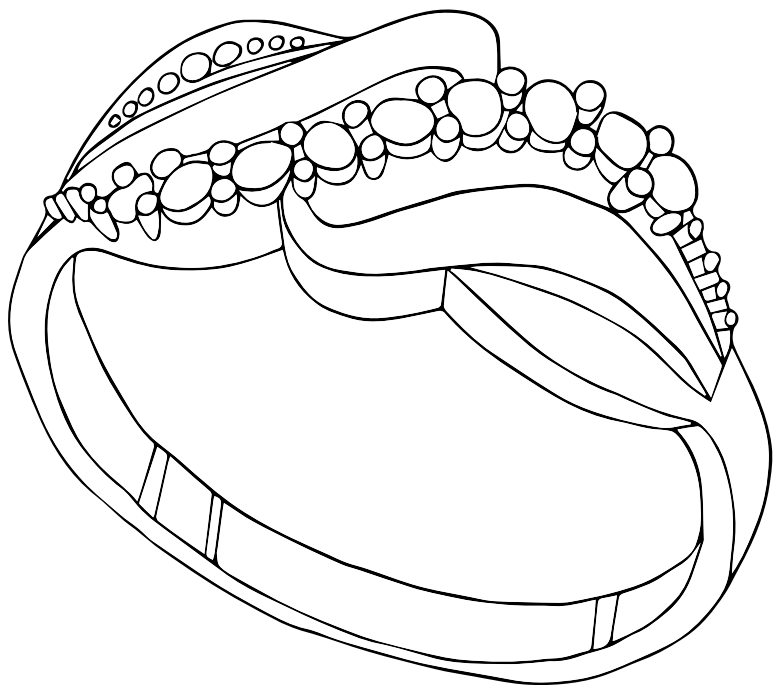

zlatý prsten  
ЗОЛОТИЙ перстень

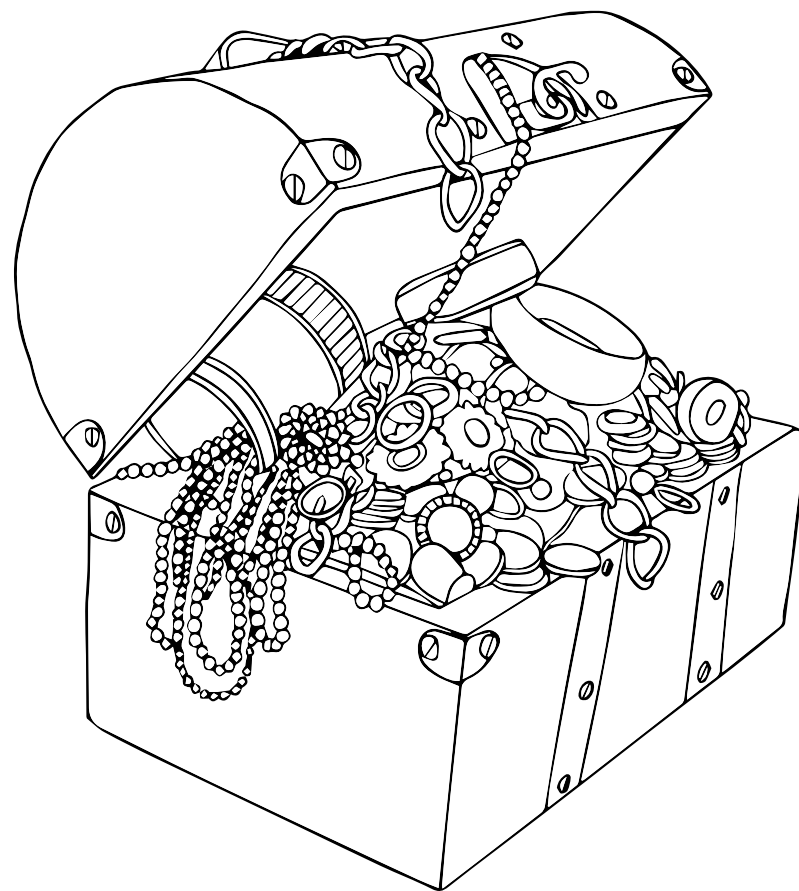

poklad  
скарб

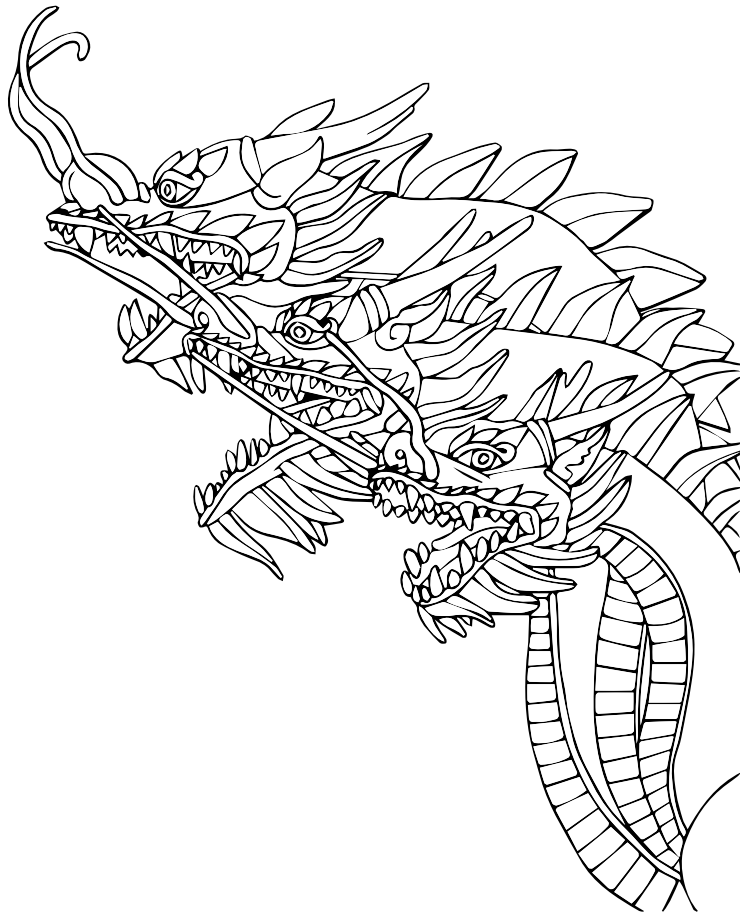

tříhlavý drak  
триголовий дракон



hrad  
замок

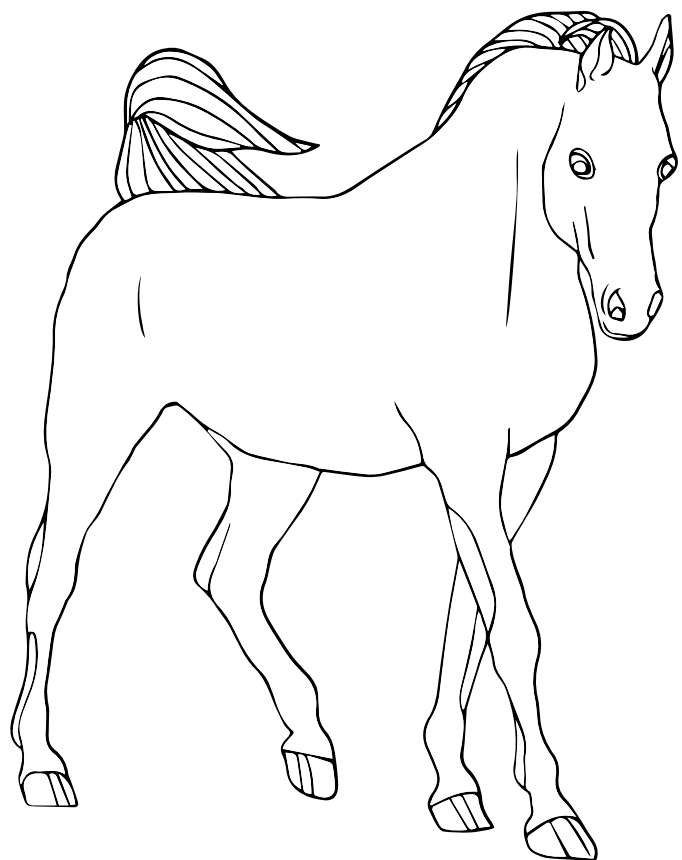

kůň  
кінь



svařák  
глiнтвейн

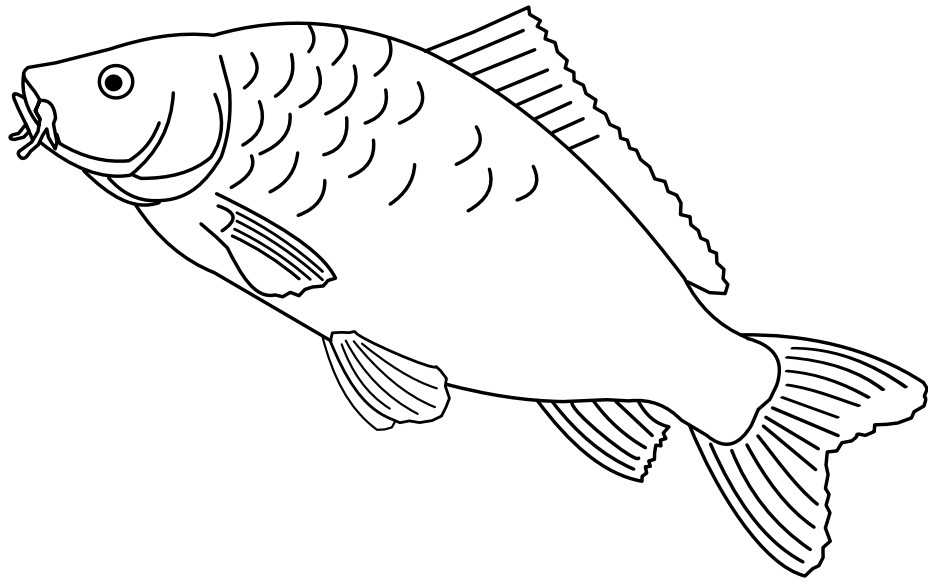

kapr  
короп

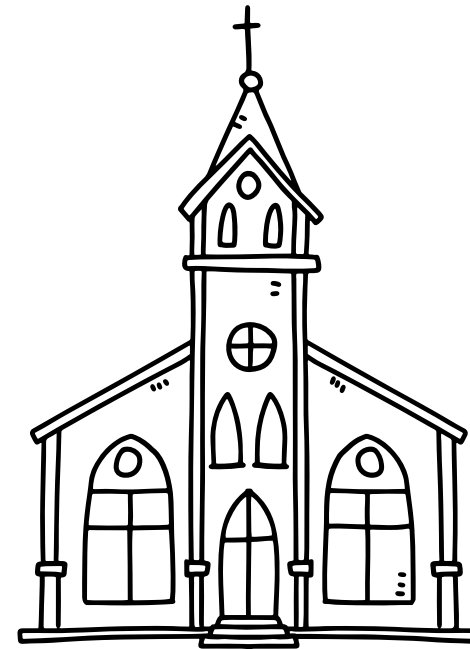

kostel  
костел

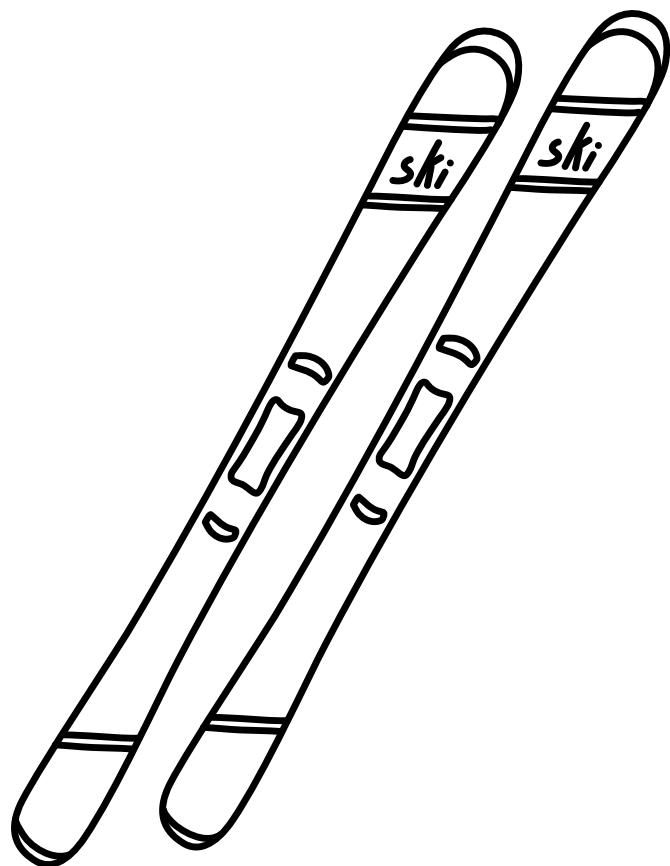

lyže  
лижі

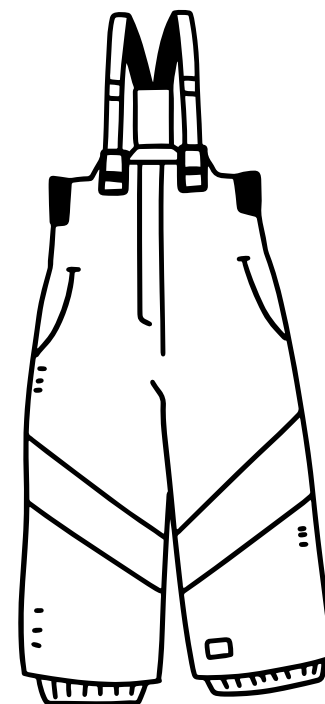

oteplováky  
лижні штани

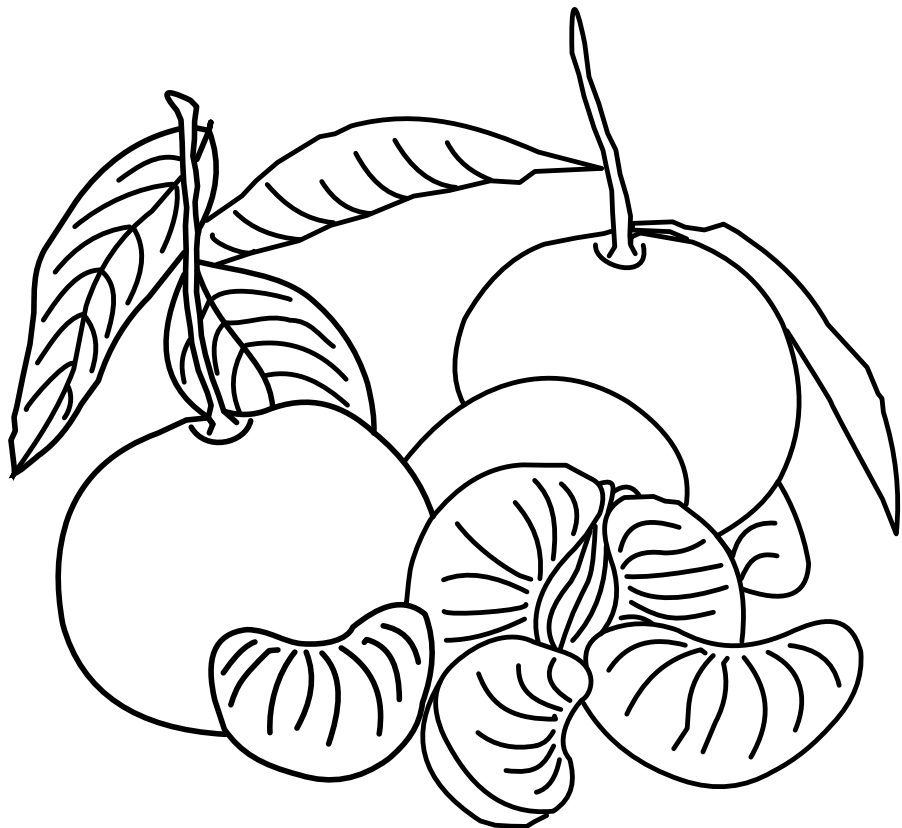

mandarinky  
мандаринки

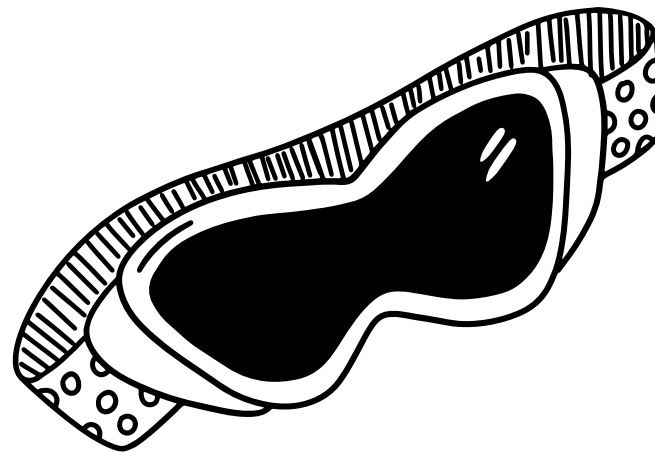

brýle  
окуляри





jmelí  
омела

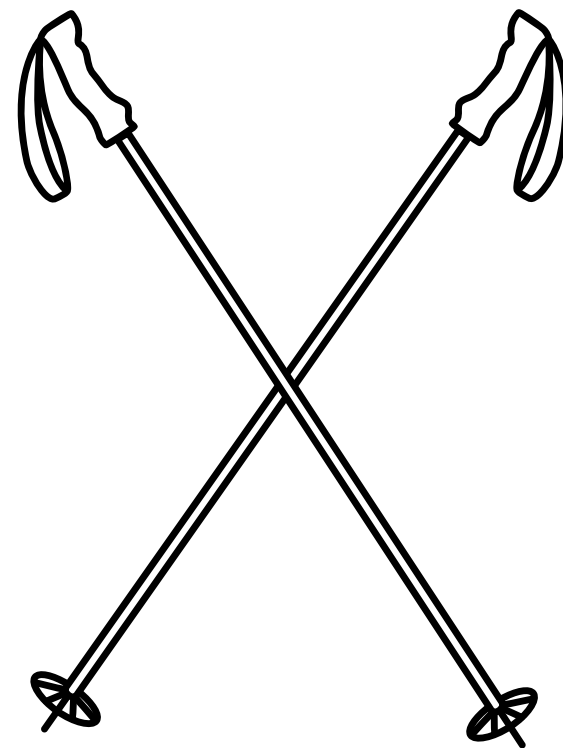

hůlky  
палки

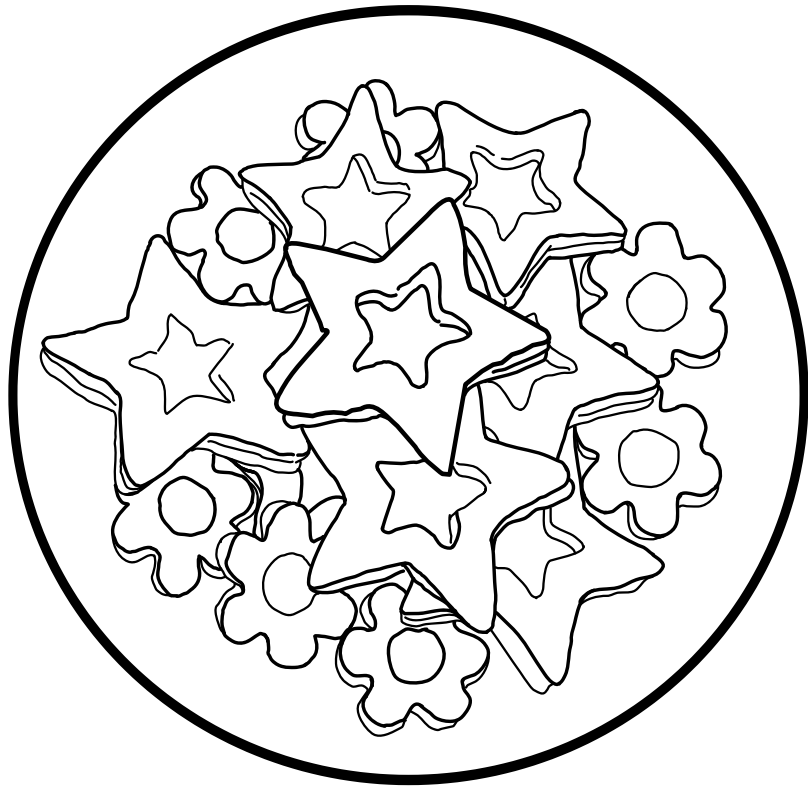

linecké  
печиво з пісочного  
тіста

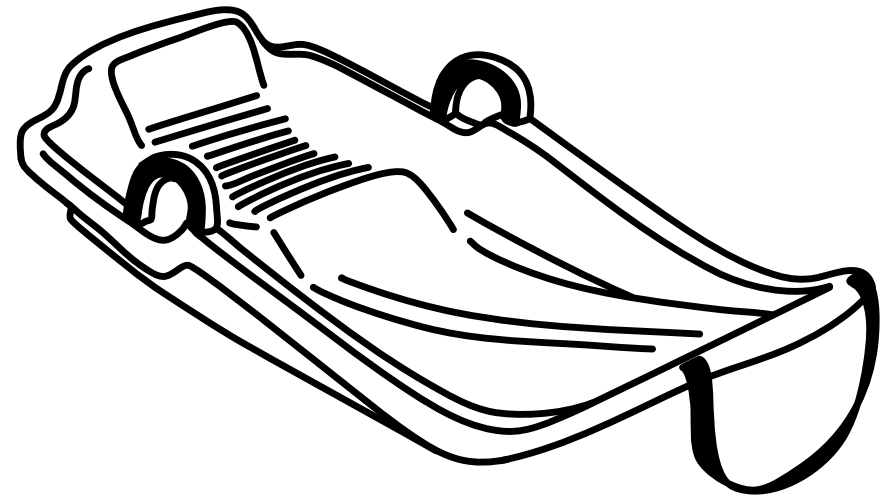

boby  
пластикові санчата



dárek  
подарунок



perníčky  
прянички

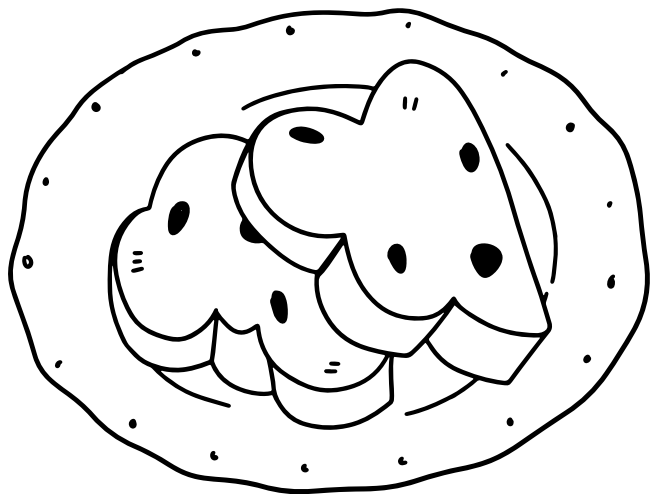

vánočka  
різдвяна булочка-  
плетінка

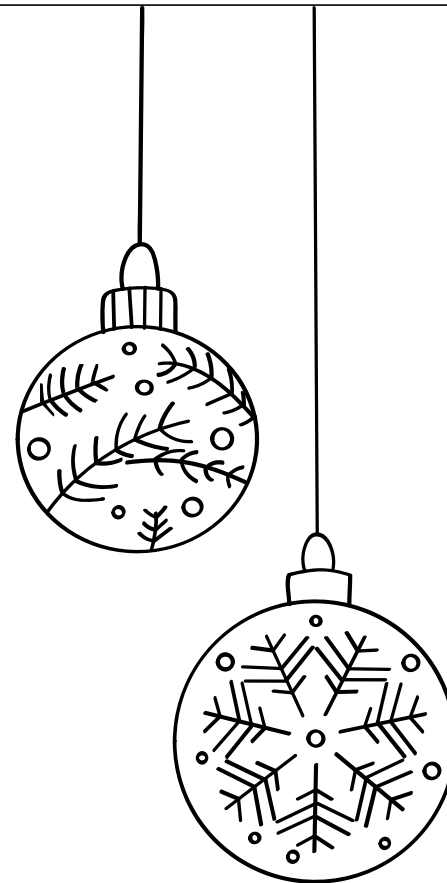

vánoční ozdoby  
різдвяні прикраси

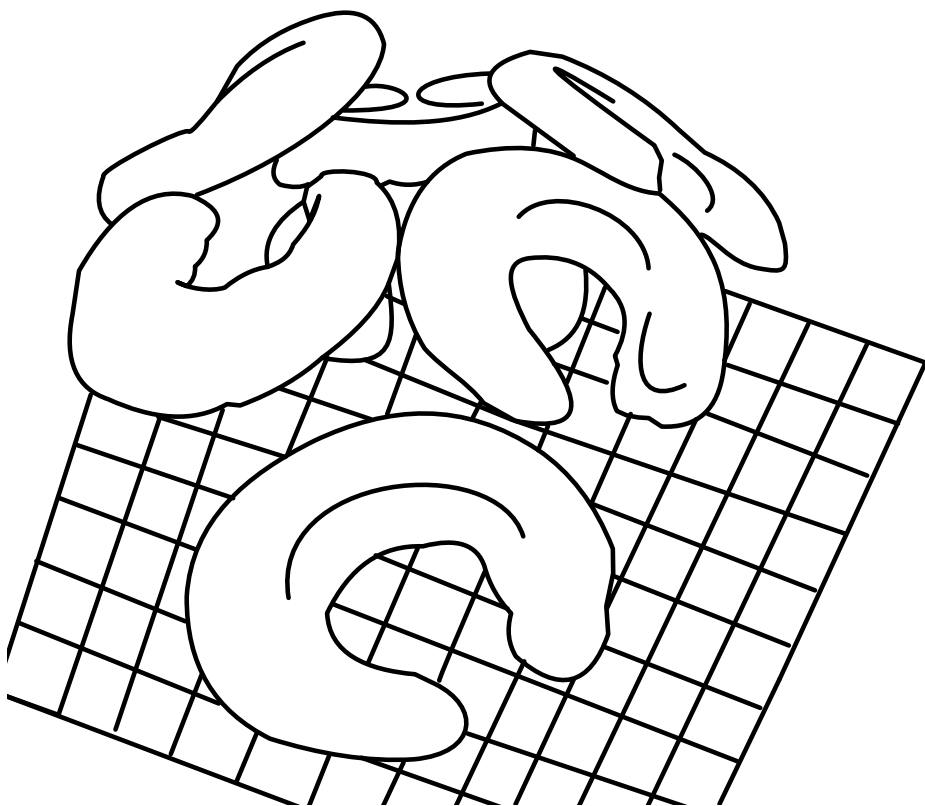

rohlíčky  
рогалики

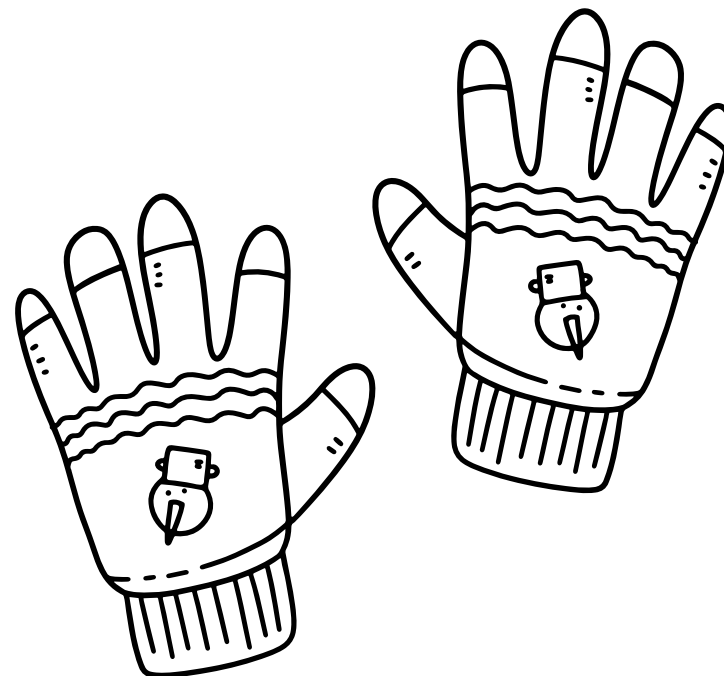

rukavice  
рукавиці

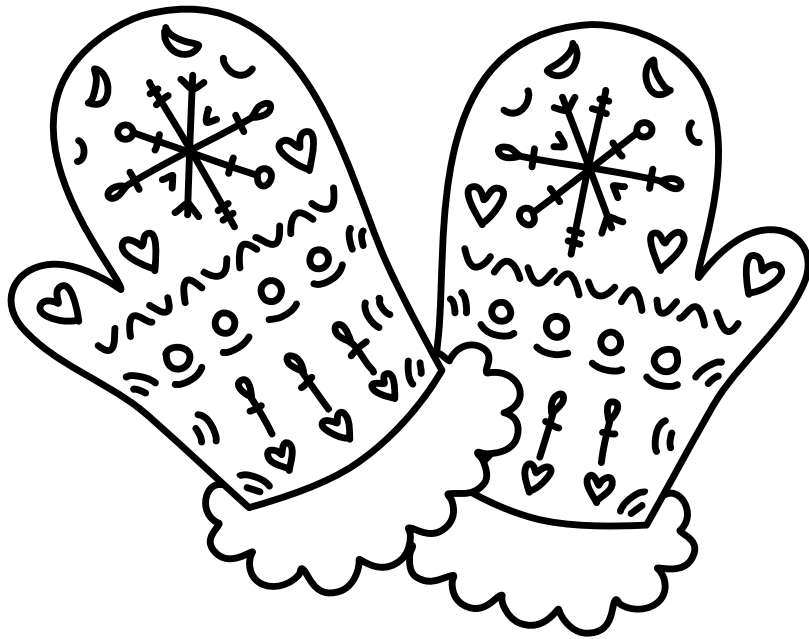

paľčáky  
рукавиці (без  
пальців)

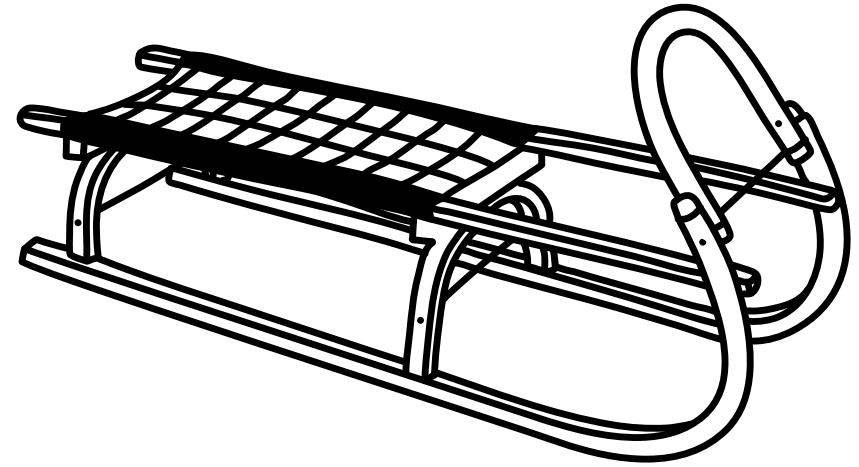

sáňky  
санчата

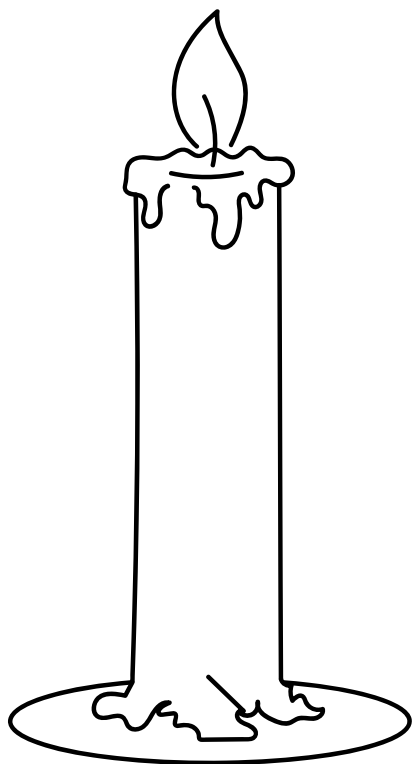

svíčka  
свічка

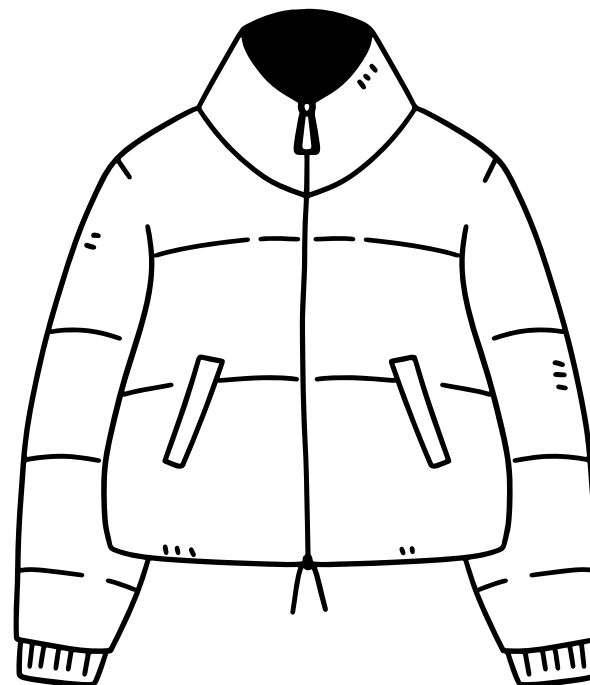

teplá bunda  
тепла куртка

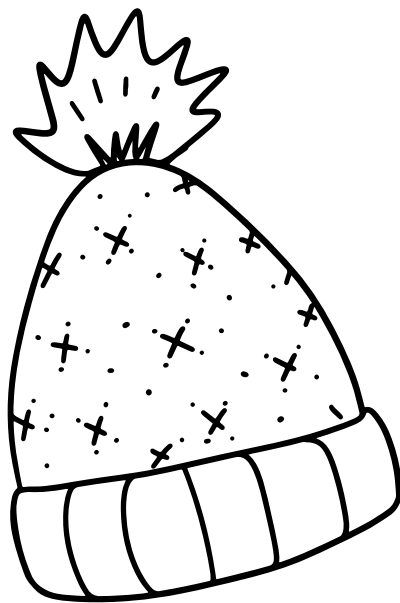

čepice  
шапка

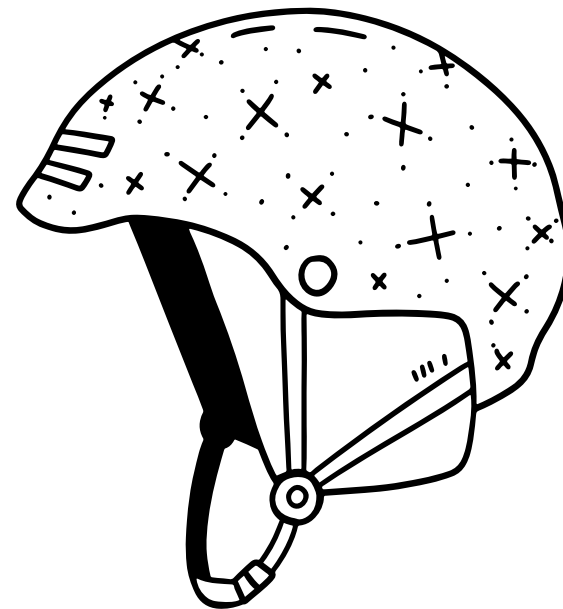

helma  
шолом



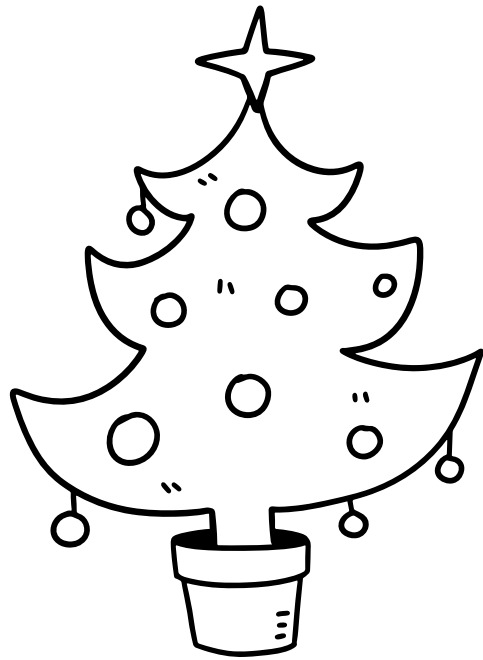

vánoční stromeček  
ялинка



lyžáky  
лижні черевики